



# 1963-65 Chevrolet Corvette

Condenser Kit *with* Drier  
(021180)



18865 Goll St. San Antonio, TX 78266  
Phone: 800-862-6658  
Sales: [sales@vintageair.com](mailto:sales@vintageair.com)  
Tech Support: [tech@vintageair.com](mailto:tech@vintageair.com)  
[www.vintageair.com](http://www.vintageair.com)



[www.vintageair.com](http://www.vintageair.com)

# Table of Contents

Cover.....	1
Table of Content/Parts Disclaimer.....	2
Important Notice.....	3
Core Support Modification.....	4
Mounting Bracket Installation.....	5
Mounting Bracket and Drier Installation.....	6
Condenser and Hardline Installation.....	7
Lubricating O-rings, Voltage Regulator Relocation.....	8
Packing List.....	9

## Parts Disclaimer: Please Read

Before beginning installation, open all packages and check contents of shipment. Please report any shortages directly to Vintage Air within 15 days. After 15 days, Vintage Air will not be responsible for missing or damaged items. Packing list located on last page of instructions.



www.vintageair.com

## Important Notice—Please Read

*For Maximum System Performance, Vintage Air Recommends the Following:*

**NOTE:** Vintage Air systems are designed to operate with R134a refrigerant only. Use of any other refrigerant could damage your A/C system and/or vehicle, and possibly cause a fire, in addition to potentially voiding the warranties of the A/C system and its components.

### Refrigerant Capacities:

**Vintage Air System:** 1.8 lbs. (28.8 oz.) or 816 grams of **R134a**, charged by weight with a quality charging station or scale. **NOTE: Use of the proper type and amount of refrigerant is critical to system operation and performance.**

**Other Systems:** Consult manufacturer's guidelines.

### Lubricant Capacities:

**New Vintage Air-Supplied Sanden Compressor:** No additional oil needed (Compressor is shipped with proper oil charge).

**All Other Compressors:** Consult manufacturer (Some compressors are shipped dry and will need oil added).

### Safety Switches

Your Vintage Air system is equipped with a binary pressure safety switch. A binary switch disengages the compressor clutch in cases of extreme low pressure conditions (refrigerant loss) or excessively high head pressure (406 PSI) to prevent compressor damage or hose rupture. A trinary switch combines Hi/Lo pressure protection with an electric fan operation signal at 254 PSI, and should be substituted for use with electric fans. Compressor safety switches are extremely important since an A/C system relies on refrigerant to circulate lubricant.

### Service Info:

**Protect Your Investment:** Prior to assembly, it is critical that the compressor, evaporator, A/C hoses and fittings, hardlines, condenser and receiver/drier remain capped. Removing caps prior to assembly will allow moisture, insects and debris into the components, possibly leading to reduced performance and/or premature failure of your A/C system. This is especially important with the receiver/drier.

Additionally, when caps are removed for assembly, **BE CAREFUL!** Some components are shipped under pressure with dry nitrogen.

**Evacuate the System for 35-45 Minutes:** Ensure that system components (Drier, compressor, evaporator and condenser) are at a temperature of at least 85°F. On a cool day, the components can be heated with a heat gun *or* by running the engine with the heater on before evacuating. Leak check and charge to specifications.

### Bolts Passing Through Cowl and/or Firewall:

To ensure a watertight seal between the passenger compartment and the vehicle exterior, for all bolts passing through the cowl and/or firewall, Vintage Air recommends coating the threads with silicone prior to installation.

### Heater Hose (not included with this kit):

Heater hose may be purchased from Vintage Air (Part#31800-VUD) or your local parts retailer. Routing and required length will vary based on installer preference.



www.vintageair.com

## Core Support Modification

**NOTE:** It is necessary to modify the core support for the condenser hardline and #6 A/C hose to pass through to the engine bay. This modification takes place in a confined area, and it may be more manageable if the core support is removed from the vehicle first. On some 64'-65' core supports, an additional hole will be present where the templated hole has to be placed. In this instance, the template can be left in place to cover the hole and accept the grommet. If the core support does not have the mounting locations for the voltage regulator, use the edge of the core support to align the template (See Photo 4, below).

1. Remove the (3) mounting screws holding the voltage regulator to the core support (See Photo 1, below).
2. Using (2) of the regulator mounting screws, install the core support hardline/hose plate in front of the core support as shown in Photos 2 and 3, below.
3. Remove the (2) areas called out in Photo 3, below.
4. Remove the plate (discard).
5. Reinstall the core support (if removed from the vehicle).

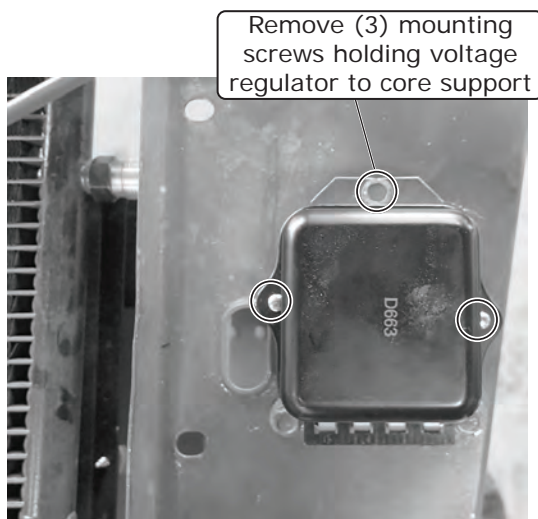

Photo 1

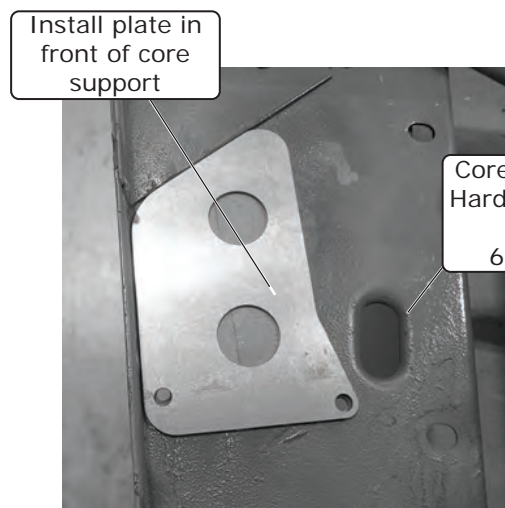

Photo 2

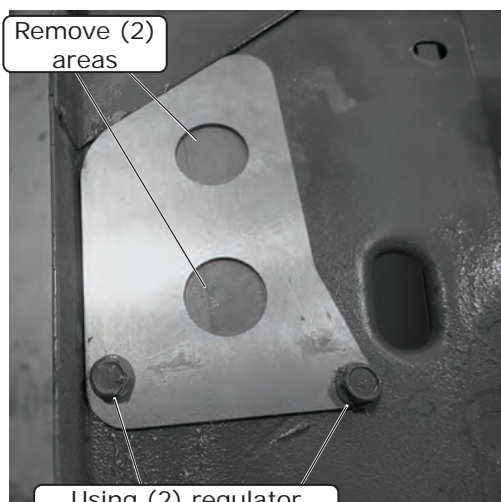

Photo 3

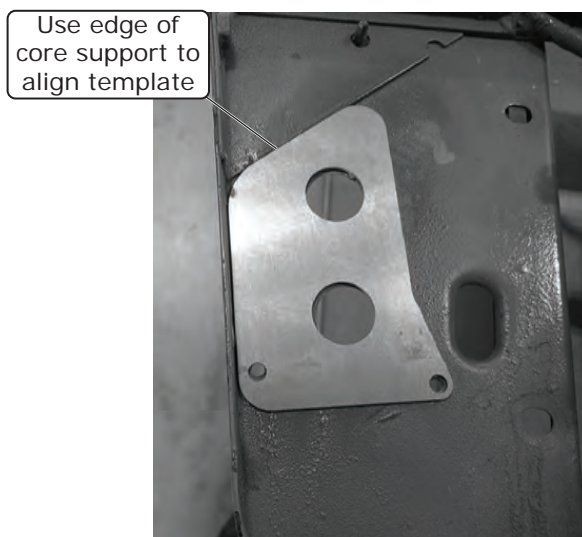

Photo 4



www.vintageair.com

# Mounting Bracket Installation

**NOTE:** Mark the hinge location on the hood, then remove the hood and remove the hood prop.

1. Install the mounting brackets onto the condenser using (4) 10-24 x 3/8" pan head screws and (4) 10-24 nuts with star washers as shown in Figure 1, below.

**Figure 1**

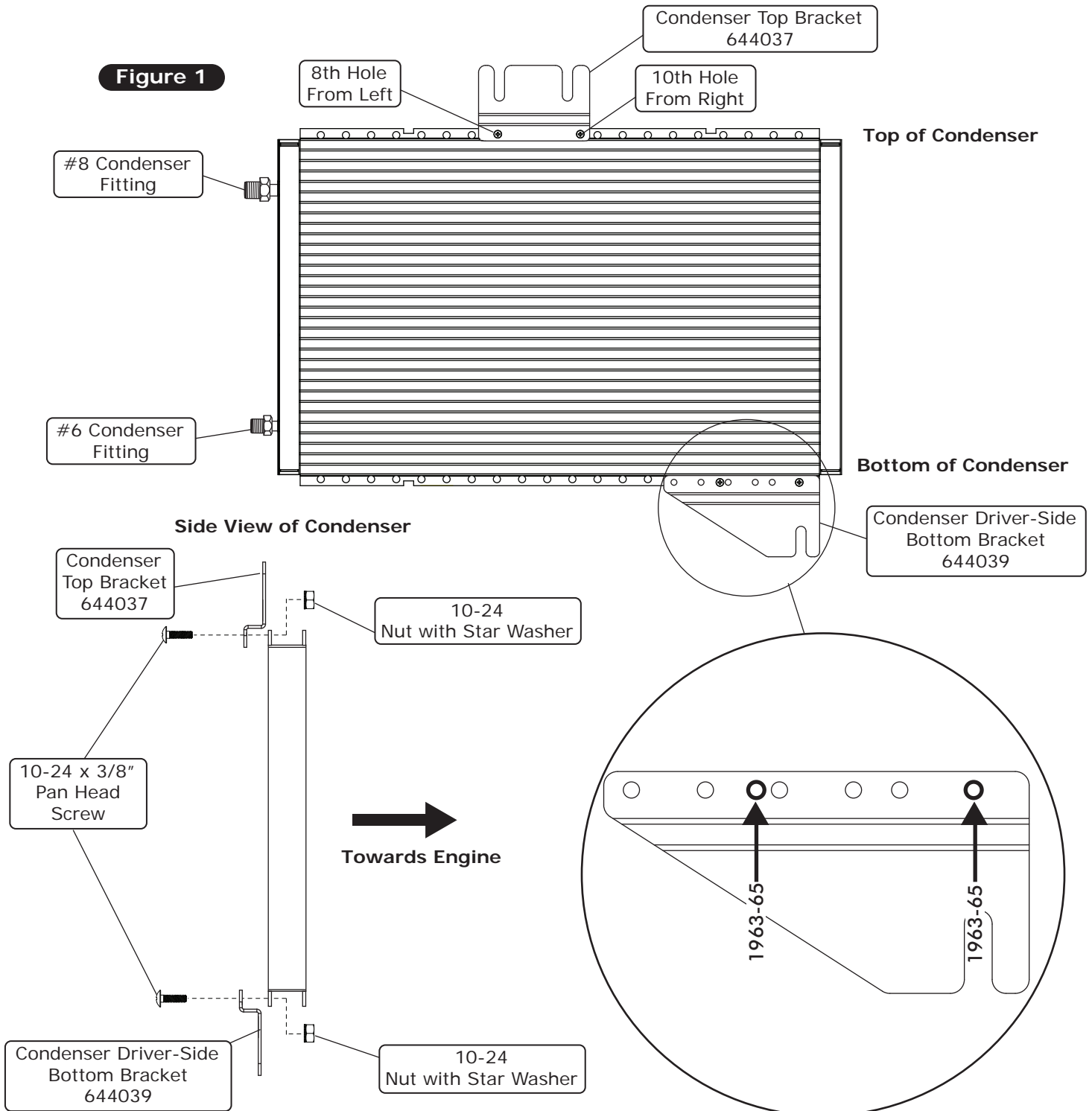



www.vintageair.com

## Mounting Bracket and Drier Installation

1. Install the mounting brackets onto the condenser using (4) 10-24 x 3/8" pan head screws and (4) 10-24 nuts with star washers as shown in Figure 1, below. **NOTE: The brackets mount through the 1st and 3rd holes in the condenser.**
2. Install the drier clamps onto the drier as shown in Figure 1, below.
3. Using (2) #10 x 1/2" sheet metal screws, install the drier onto the bracket in the 4th and 6th holes from the top (See Figure 1, below). **NOTE: Refrigerant flow through drier is in from the condenser, out to the evaporator.**

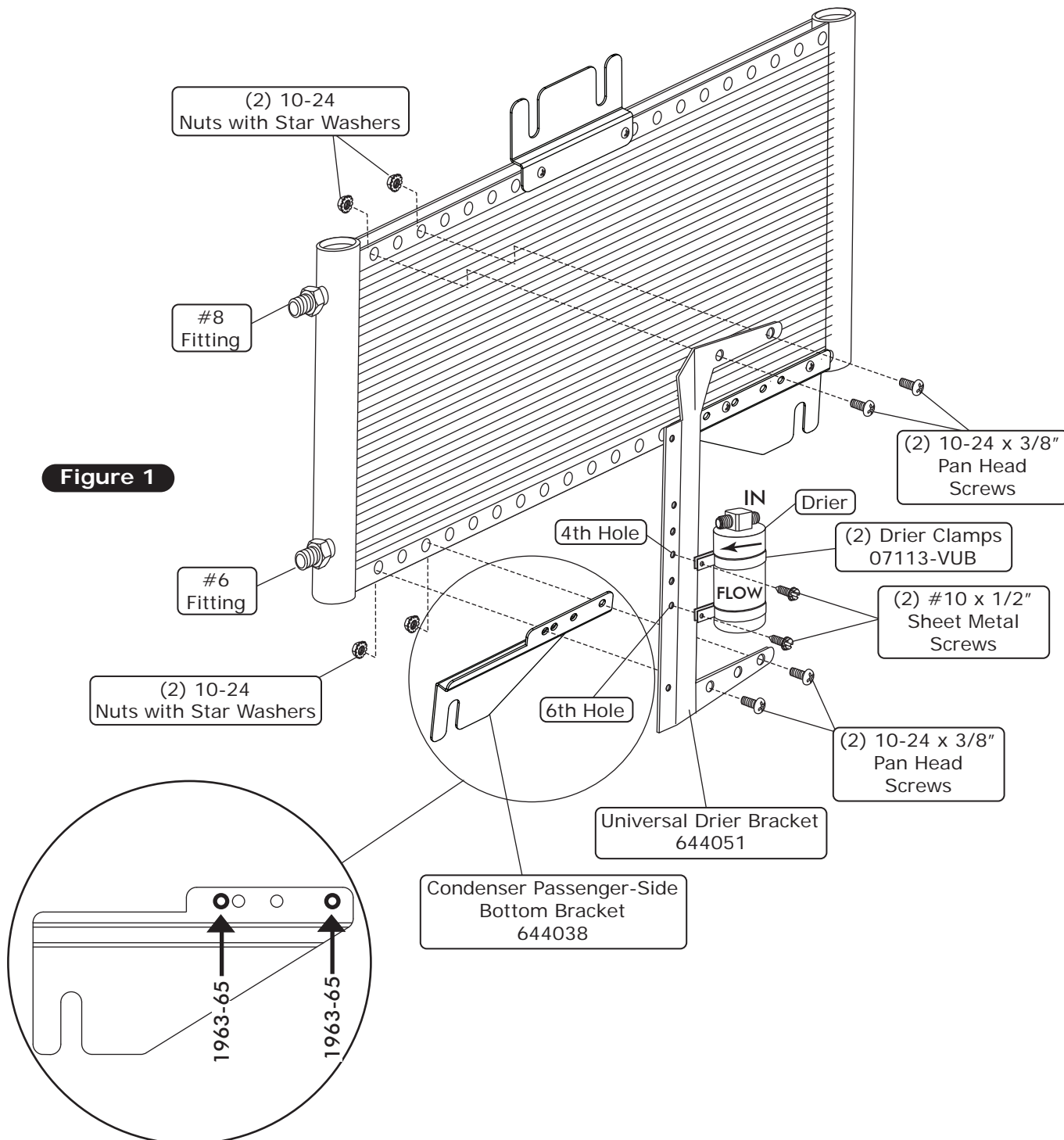



www.vintageair.com

# Condenser and Hardline Installation

**NOTE:** Drier contains a desiccant that will quickly absorb moisture from the atmosphere and can lose effectiveness in less than 30 minutes. Remove caps and plugs only long enough to install safety switch and hardlines onto a sealed condenser assembly. Do not uncap again until ready to connect hoses and evacuate system before charging.

1. Lubricate (2) #6 O-rings (See Lubricating O-rings, Page 8, and Figure 1, below), and install the #6 condenser/drier hardline as shown in Figure 1, below.
2. Install the condenser in front of the core support using the OEM bolts as shown in Figure 2, below.
3. Install the 1 1/4" O.D. x 11/16" I.D. grommet onto the #8 condenser/compressor hardline (See Photo 1, below).
4. Lubricate the #8 hardline O-ring, and route it through the core support. Install the #8 hardline onto the condenser and install the 1 1/4" O.D. x 11/16" I.D. grommet into the core support (See Photo 2, below).

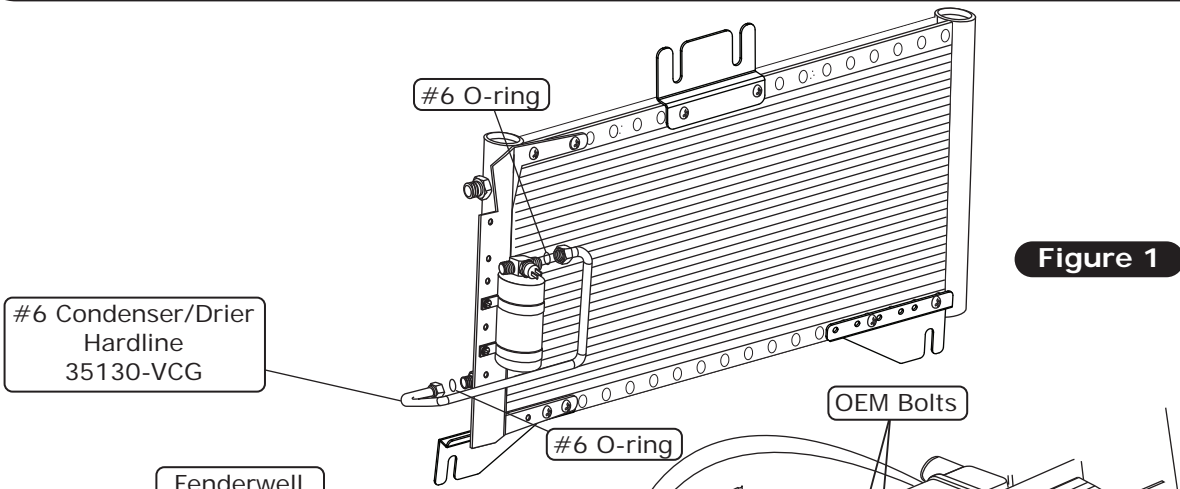

Figure 1

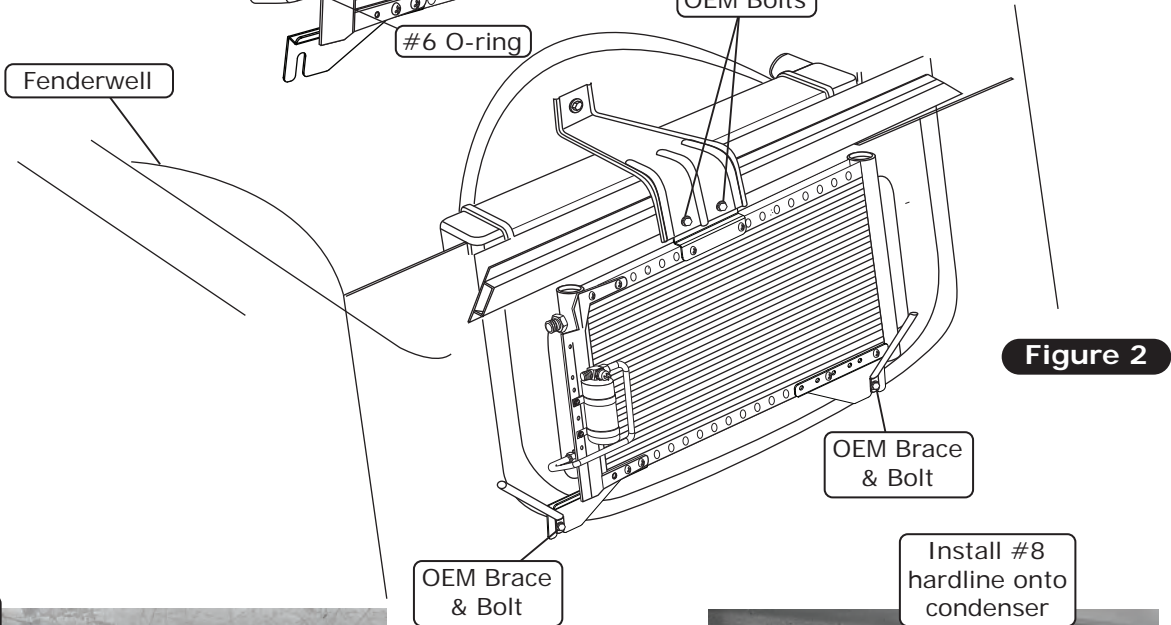

Figure 2

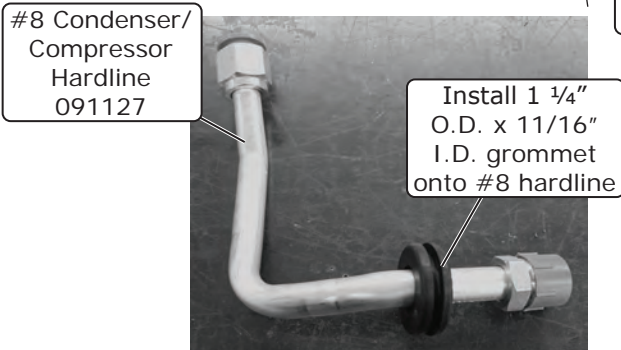

Photo 1

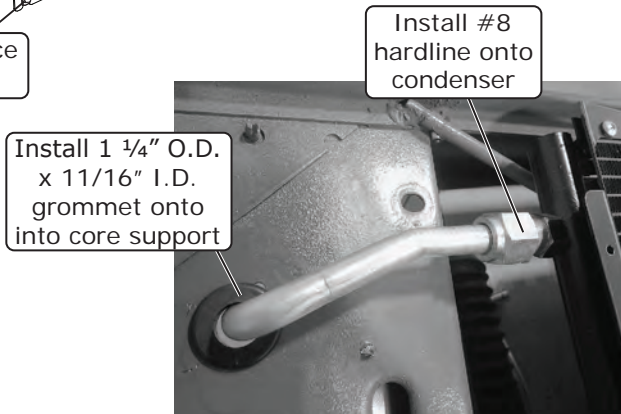
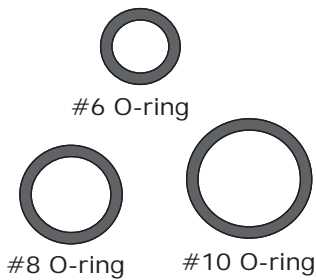

Photo 2



www.vintageair.com

## Lubricating O-rings



#6 O-ring

#8 O-ring

#10 O-ring

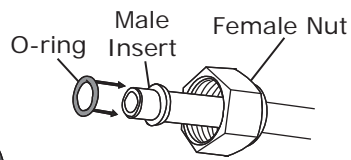

Refrigerant Oil for O-rings

O-ring installs over male insert to swaged lip

For a proper seal of fittings: Install supplied O-rings as shown and lubricate with refrigerant oil.

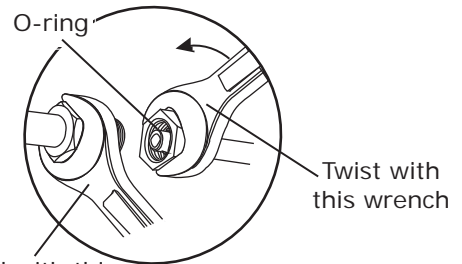

Hold with this wrench

Twist with this wrench

**NOTE: Standard torque specifications:**  
#6: 11 to 13 ft-lb.  
#8: 15 to 20 ft-lb.  
#10: 21 to 27 ft-lb.

## Voltage Regulator Relocation

**NOTE:** This step should be done after the #6 A/C hose has been installed on the drier. Photos are for reference.

1. Accommodate the voltage regulator in the area to the left of the hardline and A/C hose, then secure it to the core support using the (3) supplied #12 x 1/2" self-tapping screws (See Photos 1 and 2, below).

Accommodate voltage regulator in area to left of hardline and A/C hose

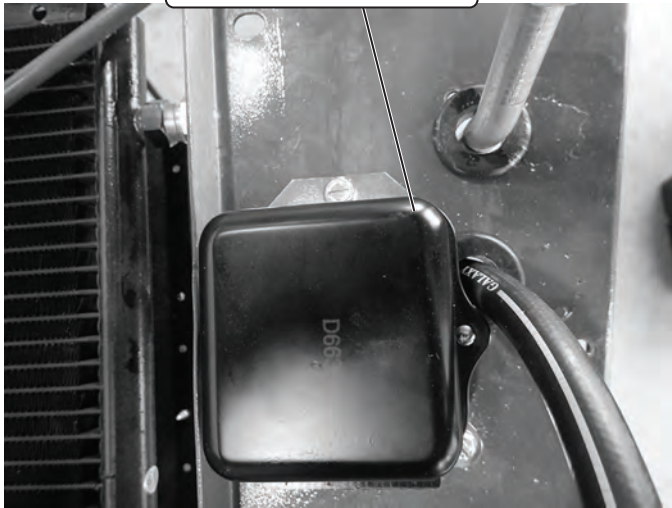

Photo 1



(3) #12 x 1/2" Self-Tapping Screws

Photo 2















www.vintageair.com

# Packing List: Condenser Kit (021180)

## O-rings/Refrigerant Oil







	Qty		Part No	Description
	3	<input type="checkbox"/>	182465	Screw, #12 x 1/2", Self-Tapping
	2	<input type="checkbox"/>	18247-VUB	Screw, #10 x 1/2", Sheet Metal
	8	<input type="checkbox"/>	18249-VUB	Screw, 10-24 x 3/8", Pan Head
	8	<input type="checkbox"/>	18260-VUB	Nut with Star Washer, 10-24
	1	<input type="checkbox"/>	23135-VUW	Compressor Lead
	2	<input type="checkbox"/>	33136-VUI	Grommet, 1 1/4" O.D. x 11/16" I.D.

Packed By: \_\_\_\_\_

	Qty		Part No	Description
	4	<input type="checkbox"/>	33857-VUF	O-ring, #6
	3	<input type="checkbox"/>	33858-VUF	O-ring, #8
	1	<input type="checkbox"/>	41117-VUP	Refrigerant Oil



Packed By: \_\_\_\_\_

## Brackets

	Qty		Part No	Description
	2	<input type="checkbox"/>	07113-VUB	Drier Clamp
	1	<input type="checkbox"/>	644037	Bracket, Condenser, Top
	1	<input type="checkbox"/>	644038	Bracket, Condenser, PS Bottom
	1	<input type="checkbox"/>	644039	Bracket, Condenser, DS Bottom
	1	<input type="checkbox"/>	644051	Bracket, Universal Drier
	1	<input type="checkbox"/>	644218	Plate, Hardline/Hose, Core Support



Packed By: \_\_\_\_\_

## Hardlines

	Qty		Part No	Description
	1	<input type="checkbox"/>	091127	Hardline, #8 Condenser/Compressor
	1	<input type="checkbox"/>	35130-VCG	Hardline, #6 Drier/Condenser

Packed By: \_\_\_\_\_

## Condenser/Drier

	Qty		Part No	Description
	1	<input type="checkbox"/>	03766-VUC	Condenser, 14" x 22", Parallel Flow
	1	<input type="checkbox"/>	07321-VUC	Drier

Packed By: \_\_\_\_\_

Inspected By: \_\_\_\_\_

Date: \_\_\_\_\_

**NOTE: Images may not depict actual parts and quantities.  
Refer to packing list for actual parts and quantities.**