



1987-93 Ford Mustang

with Factory Air
Evaporator Kit
(554970)



18865 Goll St. San Antonio, TX 78266
Phone: 800-862-6658
Sales: sales@vintageair.com
Tech Support: tech@vintageair.com
www.vintageair.com



www.vintageair.com

Table of Contents

Cover.....	1
Table of Contents.....	2
Packing List/Parts Disclaimer.....	3
Information Page.....	4
Wiring Notice.....	5
Engine Compartment Disassembly.....	6
Passenger Compartment Disassembly.....	7-12
Firewall Modification and Insulation, Properly Seated O-ring Land.....	13-14
Lubricating O-rings, Evaporator Preparation.....	14-17
Firewall Cover Preparation and Installation.....	18
Drain Hole Cover Installation.....	19
Passenger Compartment Wiring.....	20-21
Evaporator Installation, Drain Hose Installation.....	22-23
A/C Hose Installation.....	24-25
Heater Control Valve Preparation, Heater Control Valve Installation.....	26-28
Dash Louver Adapter Preparation.....	28-30
Engine Compartment Wiring, Passenger Compartment Wiring Final, Dash Reassembly.....	31-33
Console Reassembly, Control Panel Installation, Passenger Compartment Reassembly, Engine Compartment Reassembly.....	34
Final Steps: Installation Check.....	35
Final Steps: Completing the Install.....	36
ECU, Control Panel & Duct Hose Routing.....	37
Quality Crimp Guideline.....	38
Gen 5 Wiring Diagram.....	39
Gen 5 Wiring Connection Instruction.....	40
Operation of Controls.....	41
Troubleshooting Guide.....	42
Troubleshooting Guide (Cont.), Advanced Diagnostics and Troubleshooting Guide.....	43
Packing List.....	44



www.vintageair.com

Packing List: Evaporator Kit (554970)

No.	Qty.	Part No.	Description
1.	1	765200	Gen 5 Super Magnum Module with 404 ECU
2.	1	784970	Accessory Kit

**** Before beginning installation, open all packages and check contents of shipment. Please report any shortages directly to Vintage Air within 15 days. After 15 days, Vintage Air will not be responsible for missing or damaged items.**

1



Gen 5 Super Magnum
Module with 404 ECU
765200

2

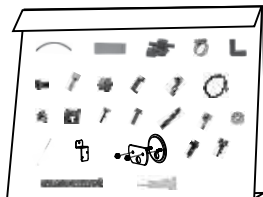
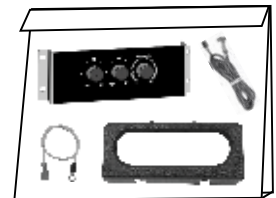
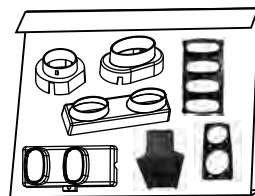
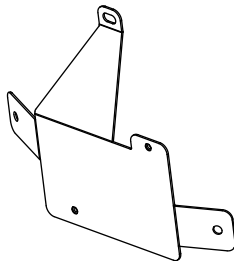
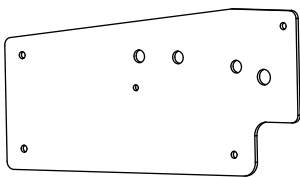
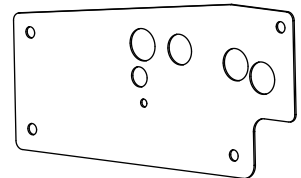
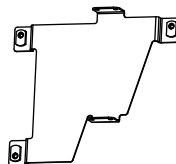
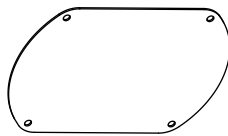
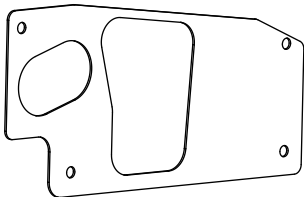
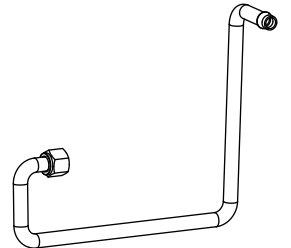
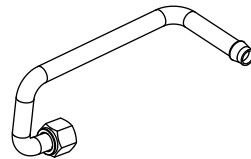
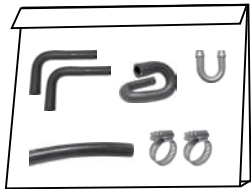

Accessory Kit
784970

NOTE: Images may not depict actual parts and quantities. Refer to packing list for actual parts and quantities.



www.vintageair.com

Important Notice—Please Read

For Maximum System Performance, Vintage Air Recommends the Following:

NOTE: Vintage Air systems are designed to operate with R134a refrigerant only. Use of any other refrigerant could damage your A/C system and/or vehicle, and possibly cause a fire, in addition to potentially voiding the warranties of the A/C system and its components.

Refrigerant Capacities:

Vintage Air System: 1.8 lbs. (28.8 oz.) or 816 grams of **R134a**, charged by weight with a quality charging station or scale. **NOTE: Use of the proper type and amount of refrigerant is critical to system operation and performance.**

Other Systems: Consult manufacturer's guidelines.

Lubricant Capacities:

New Vintage Air-Supplied Sanden Compressor: No additional oil needed (Compressor is shipped with proper oil charge).

All Other Compressors: Consult manufacturer (Some compressors are shipped dry and will need oil added).

Safety Switches

Your Vintage Air system is equipped with a binary pressure safety switch. A binary switch disengages the compressor clutch in cases of extreme low pressure conditions (refrigerant loss) or excessively high head pressure (406 PSI) to prevent compressor damage or hose rupture. A trinary switch combines Hi/Lo pressure protection with an electric fan operation signal at 254 PSI, and should be substituted for use with electric fans. Compressor safety switches are extremely important since an A/C system relies on refrigerant to circulate lubricant.

Service Info:

Protect Your Investment: Prior to assembly, it is critical that the compressor, evaporator, A/C hoses and fittings, hardlines, condenser and receiver/drier remain capped. Removing caps prior to assembly will allow moisture, insects and debris into the components, possibly leading to reduced performance and/or premature failure of your A/C system. This is especially important with the receiver/drier.

Additionally, when caps are removed for assembly, **BE CAREFUL!** Some components are shipped under pressure with dry nitrogen.

Evacuate the System for 35-45 Minutes: Ensure that system components (Drier, compressor, evaporator and condenser) are at a temperature of at least 85°F. On a cool day, the components can be heated with a heat gun **or** by running the engine with the heater on before evacuating. Leak check and charge to specifications.

Bolts Passing Through Cowl and/or Firewall:

To ensure a watertight seal between the passenger compartment and the vehicle exterior, for all bolts passing through the cowl and/or firewall, Vintage Air recommends coating the threads with silicone prior to installation.

Heater Hose (not included with this kit):

Heater hose may be purchased from Vintage Air (Part#31800-VUD), Vintage Air Molded Hose Kit (Part# 545019) or your local parts retailer. Routing and required length will vary based on installer preference.



www.vintageair.com

Important Wiring Notice—Please Read

Some vehicles may have had some or all of their radio interference capacitors removed. There should be a capacitor found at each of the following locations:

- 1. On the positive terminal of the ignition coil.**
- 2. If there is a generator, on the armature terminal of the generator.**
- 3. If there is a generator, on the battery terminal of the voltage regulator.**

Most alternators have a capacitor installed internally to eliminate what is called “whining” as the engine is revved. If whining is heard in the radio, or just to be extra cautious, a radio interference capacitor can be added to the battery terminal of the alternator.

It is also important that the battery lead is in good shape and that the ground leads are not compromised. There should be a heavy ground from the battery to the engine block, and additional grounds to the body and chassis.

If these precautions are not observed, it is possible for voltage spikes to be present on the battery leads. These spikes come from ignition systems and charging systems, and from switching some of the vehicle’s other systems on and off. Modern computer-operated equipment can be sensitive to voltage spikes on the power leads, which can cause unexpected resets, strange behavior and/or permanent damage.

Vintage Air strives to harden our products against these types of electrical noise, but there is a point where a vehicle’s electrical system can be degraded so much that nothing can help.

Radio interference capacitors should be available at most auto and truck parts suppliers. They typically are cylindrical in shape, a little over an inch long and a little over a half-inch in diameter, and they have a single lead coming from one end of the cylinder with a terminal on the end of the wire, as well as a mounting clip which is screwed into a good ground on the vehicle. The specific value of the capacitance is not too significant in comparison to ignition capacitors that are matched with the coil to reduce pitting of the points.

- Care must be taken, when installing the compressor lead, not to short it to ground. The compressor lead must not be connected to a condenser fan or to any other auxiliary device. Shorting to ground or connecting to a condenser fan or any other auxiliary device may damage wiring or the compressor relay, and/or cause a malfunction.
- When installing ground leads on Gen 5 systems, the blower control ground and ECU ground must be connected directly to the negative battery post.
- For proper system operation, the heater control valve must be connected to the ECU.



www.vintageair.com

Engine Compartment Disassembly

NOTE: Before starting the installation, check the function of the vehicle (horn, lights, etc.) for proper operation, study the instructions, illustrations, photos & diagrams. Retain OEM bolts, washers and nuts, as some hardware will be reused.

Perform the following:

1. Disconnect the battery.
2. Evacuate the A/C system (if necessary).
3. Drain the radiator.
4. Disconnect the A/C hardlines coming from the condenser using a proper spring lock tool (See Photo 1, below).
5. Unplug the electrical connections and A/C lines going to the accumulator, then remove it (See Photo 2, below).
6. Disconnect the hardline coming from the firewall (See Photo 3, below).
7. Remove the heater hoses (See Photo 4, below).
8. Remove the (2) nuts holding the accumulator bracket, remove the bracket, then remove the (2) nuts behind it (See Photos 5 and 6, below).



Disconnect A/C hardlines coming from condenser

Photo 1

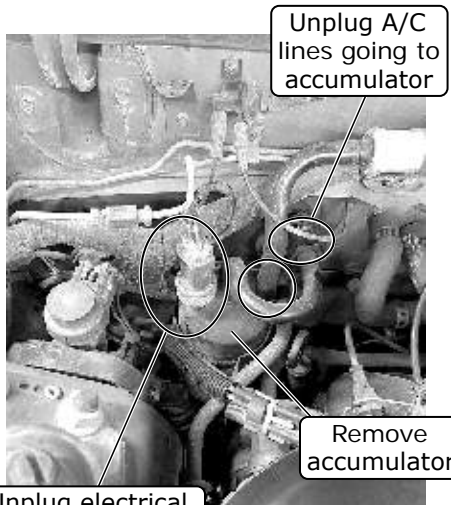

Unplug electrical connections going to accumulator

Photo 2

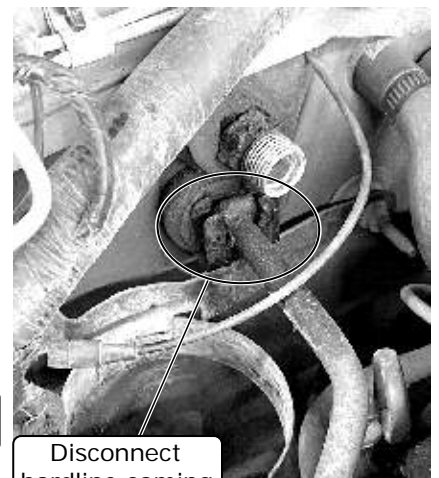

Disconnect hardline coming from firewall

Photo 3

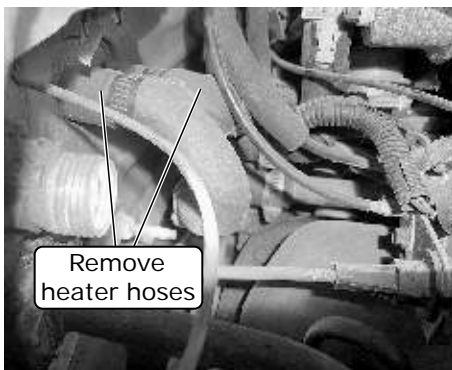

Remove heater hoses

Photo 4

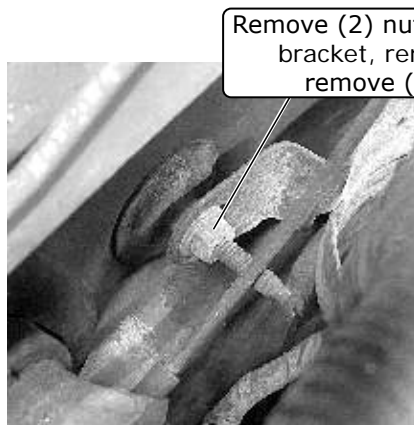

Remove (2) nuts holding accumulator bracket, remove bracket, then remove (2) nuts behind it

Photo 5



Photo 6



www.vintageair.com

Passenger Compartment Disassembly

NOTE: The removal of the dash is required to remove the OEM evaporator unit from the vehicle. Refer to the vehicle shop manual for more detailed information. Retain OEM bolts, washers and nuts, as some hardware will be reused. Removal of the front seats is not necessary, but is recommended, as it will make the dash removal easier.

1. **Optional Step** - Remove the front seats by removing the (2) nuts in the front (See Photo 1, below) and the (2) bolts on the back of the seating bracket (See Photo 2, below).
2. On the back of the console, unclip the oval shaped covers on either side, then remove (2) bolts (per side) behind them (See Photos 3 and 4, below). Once this is done, the armrest can be removed.
3. Remove the shifter cover plate by prying up with a trim panel or other suitable tool (See Photo 5, below).
4. Remove the center console top panel and electrical connections (See Photos 6 and 7, below).

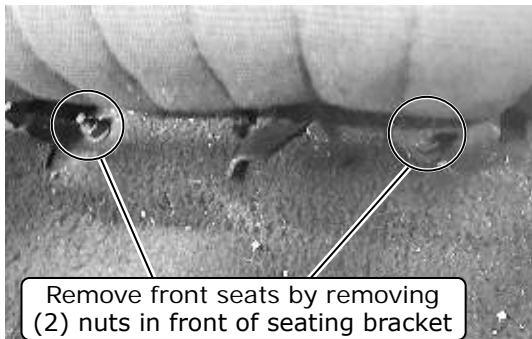

Photo 1

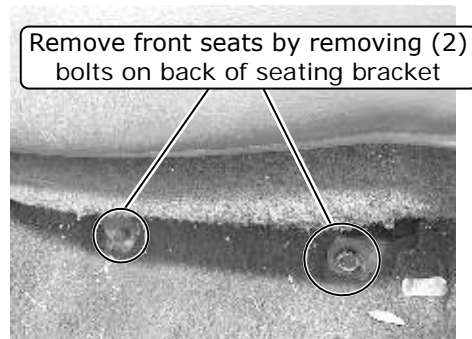

Photo 2

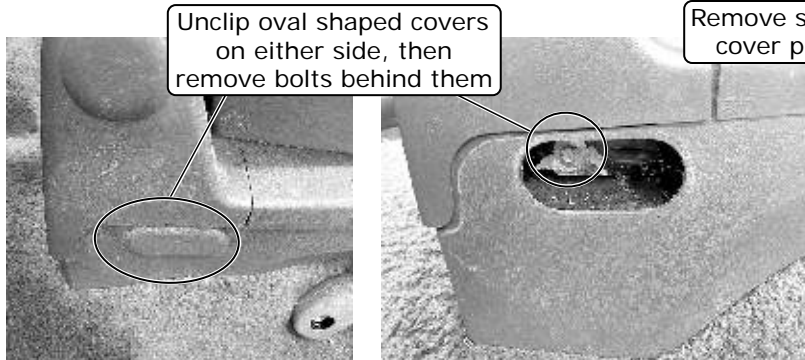

Photo 3

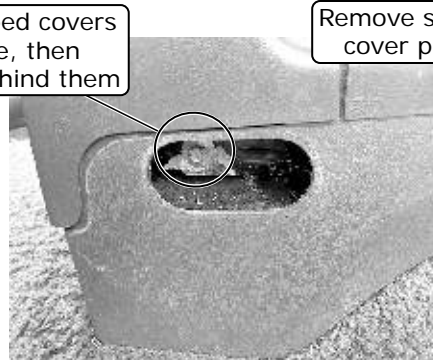

Photo 4



Photo 5

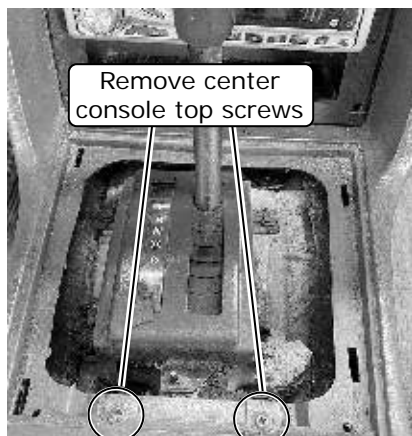

Photo 6

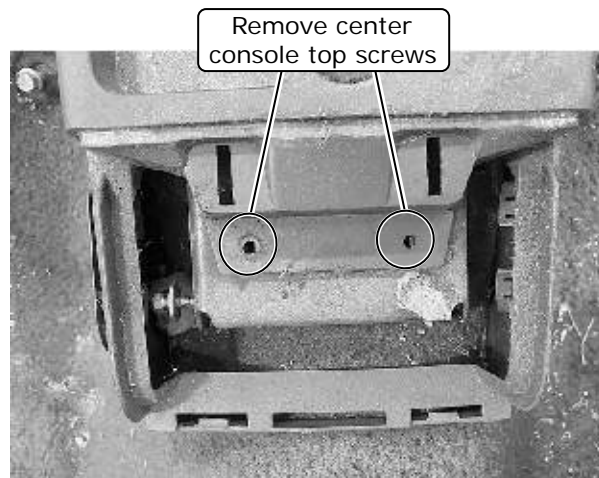

Photo 7



www.vintageair.com

Passenger Compartment Disassembly (Cont.)

5. Remove the (2) bolts holding the glove box, then remove it (See Photo 8, below).
6. Remove the A/C control bezel. Remove the (4) screws for the radio bezel (See Photo 9, below) and the (4) screws for the A/C controls (See Photo 10, below). **NOTE: The radio shown in Photo 9, below, is an aftermarket radio. A stock radio will require radio removal tools or other "homegrown" methods for removal of the radio. Vintage Air recommends using performance tool (W80230).**
7. On the back of the control panel, identify the Brown/Orange striped wire on the 4-pin connector (See Photo 11, below). Cut this wire at the connector and separate it from the rest of the harness for wiring later.
8. On the back of the control panel, identify the Light Blue/Red striped wire on the 2-pin connector (See Photo 12, below). Cut this wire at the connector and separate it from the rest of the harness for wiring later.
NOTE: Some OEM control panel harnesses will have (2) Light Blue/Red striped wires together at the same terminal (See Photo 13, below). If so, cut and separate both.

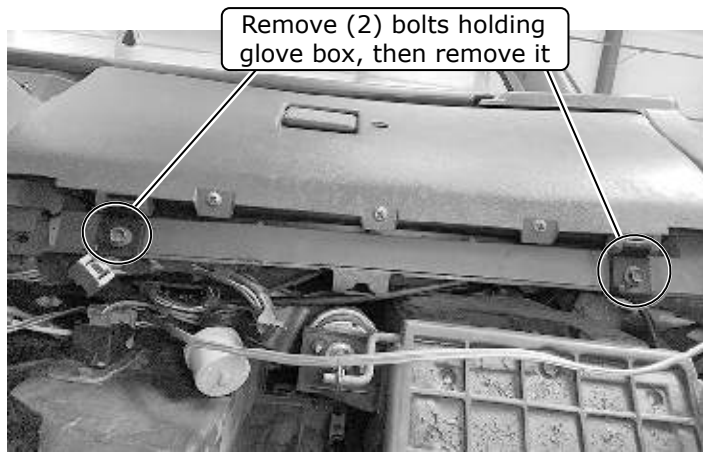

Photo 8

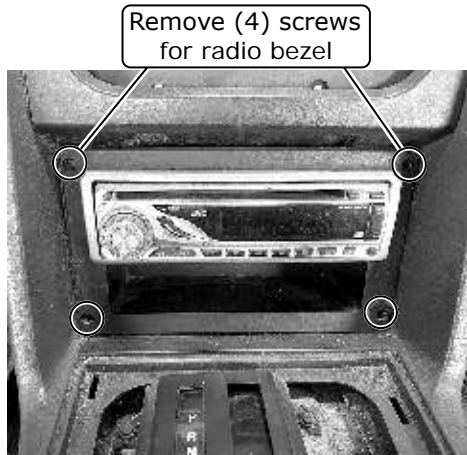

Photo 9

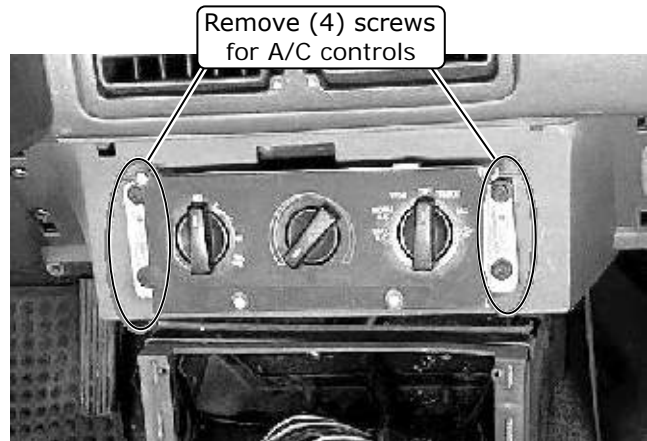

Photo 10

Identify Brown/Orange striped wire on 4-pin connector

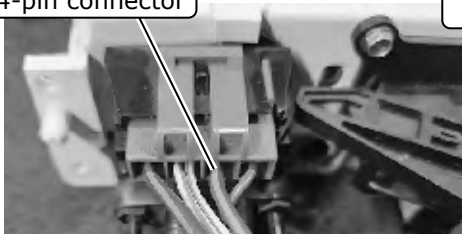

Photo 11

Identify Light Blue/Red striped wire on 2-pin connector

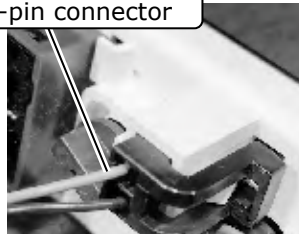

Photo 12

Some OEM control panel harnesses will have (2) Light Blue/Red striped wires together at the same terminal

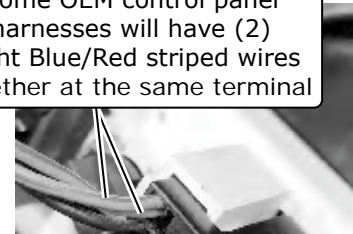

Photo 13



www.vintageair.com

Passenger Compartment Disassembly (Cont.)

9. Remove the knee bolster trim and the plate behind it (See Photos 14 and 15, below). **NOTE: The knee bolster trim and plate are found on 1990-93 Mustang airbags only.**
10. Remove the (2) screws at the rear of the center console (See Photo 16, below) and the (4) screws on the front (See Photo 17, below) holding in the center console, then remove it. **NOTE: Some year models use screws on the forward sides of the console securing the console to the floor bracket bolted to the floor behind the radio. If the car has power trunk/hatch release or power fuel door release, the switches at the edge of the console by the glove box will need to have their connectors disconnected, as the switches come out with the console.**

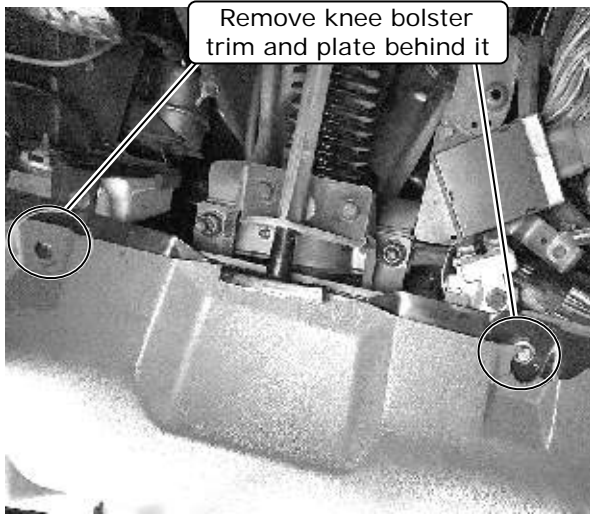

Photo 14



Photo 15



Photo 16

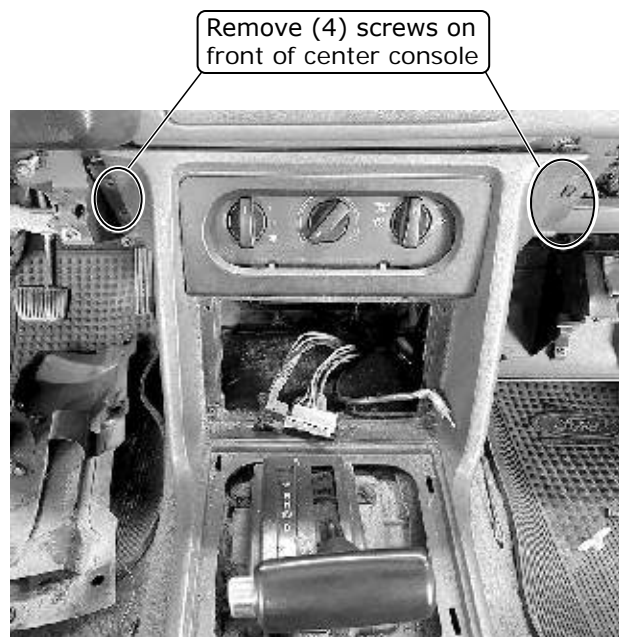

Photo 17



www.vintageair.com

Passenger Compartment Disassembly (Cont.)

11. Remove the threshold trim (See Photo 18, below) and unclip the kick panels or remove the very forward most screw, which allows the kick panel to be removed on each side. Disconnect the electrical connections behind the passenger-side kick panel. **NOTE: It is optional to remove the very forward most screw, which allows the kick panel to be removed on each side. No need to fully remove the door sill plates.**
12. Remove the (2) screws retaining the steering column trim, then remove the top and bottom trim pieces (See Photo 19, below).
13. Remove the lower dash brace from the steering column by removing the (4) screws (See Photo 20, below).
14. Remove the (2) bolts securing the hood release, then remove it (See Photo 21, below).

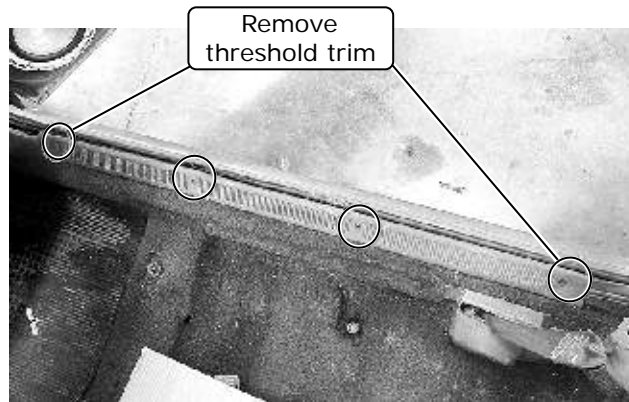

Photo 18

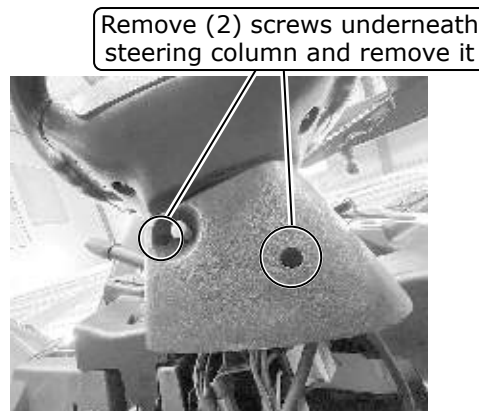

Photo 19

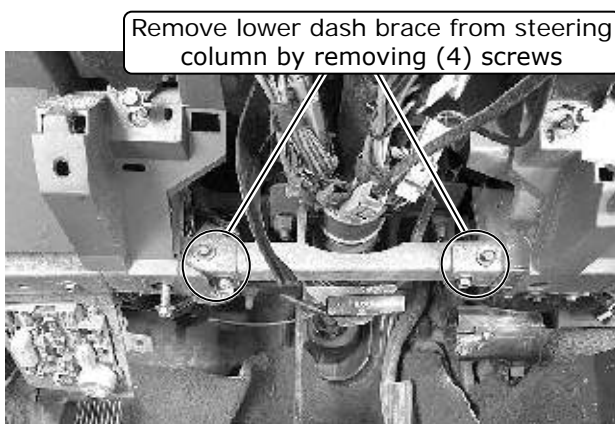

Photo 20

Remove (2) bolts to remove hood release



Photo 21

Passenger Compartment Disassembly (Cont.)

15. On the steering column, remove the (2) bolts closest to you to remove the first bracket (See Photo 22, below). Then, the (2) bolts behind the first bracket (See Photo 23, below) and the (2) bolts closest to the firewall.
16. Loosen the nut on the stud above the steering column (See Photo 24, below).
17. Disconnect the airbag harness and steering column electrical connections.
18. On the instrument cluster bezel, remove the switches on both sides by pushing in the (2) retaining tabs behind the switches (See Photo 25, below). Then, remove the (4) screws holding in the top and bottom of the bezel, as well as the screw holding in the bezel bracket (See Photo 26, below). Remove the bezel.

On steering column, remove (2) bolts closest to you to remove first bracket

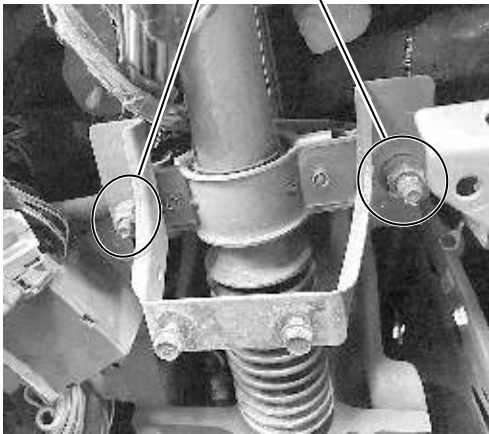

Photo 22

Remove (2) bolts behind first bracket

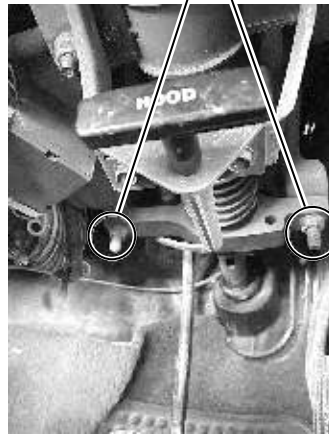
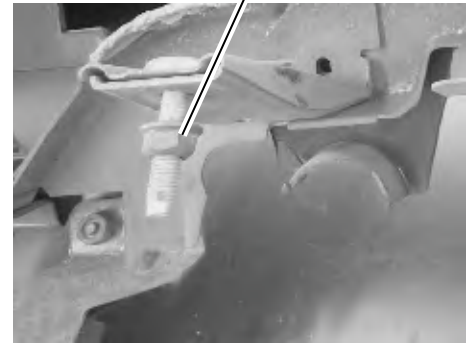

Photo 23

Loosen nut on stud above steering column



View from Back of Dash

Photo 24

On instrument cluster bezel, remove switches on both sides by pushing in the (2) retaining tabs behind the switches



Photo 25

Remove screw holding in bezel bracket

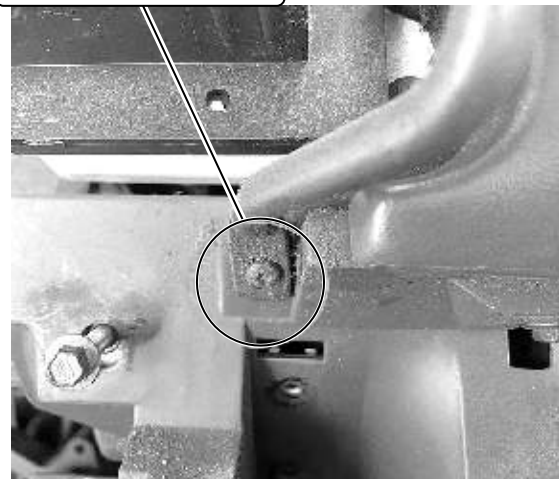

Photo 26



www.vintageair.com

Passenger Compartment Disassembly (Final)

19. Remove the speaker covers and pry out the defrost trim, then remove the (5) screws along the top of the dash (See Photo 27, below).
20. Remove the (2) screws on either side of the kick panel area, then remove the dash (See Photos 28 and 29, below).
21. Remove the (2) screws on the cowl brackets and (1) screw at the bottom of the module, then remove the evaporator unit (See Photo 29, below).

Remove (5) screws along top of dash



Photo 27

Remove screw on side of kick panel area



Photo 28

Remove (2) screws on cowl brackets and (1) screw at bottom of module, then remove evaporator unit

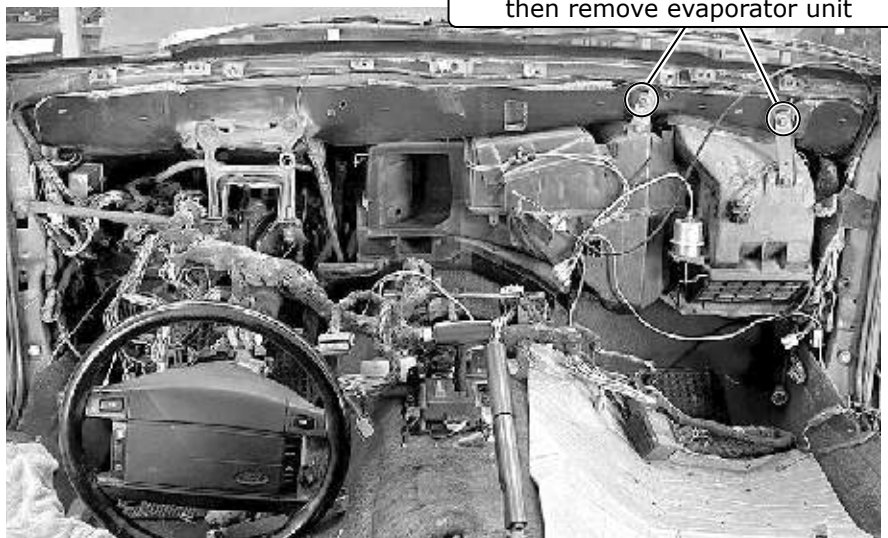

Photo 29



www.vintageair.com

Firewall Modification and Insulation

NOTE: To ensure a watertight seal between the passenger compartment and the vehicle exterior, for all bolts passing through the firewall or cowl, Vintage Air recommends coating the threads with silicone prior to installation.

Perform the following:

1. Cut the OEM firewall insulation approximately from the center of the transmission tunnel, then remove (See Photos 1 and 2, below). **NOTE:** This can be used as a template to cut Dynaliner or equivalent 1/8"-1/4" insulation for replacement.
2. Using the firewall cover template, place it inside on the firewall, over the factory openings (See Photo 3, below). Align the lower-right hole with the bottom-left firewall hole (See Photo 4, below).
3. Using the (2) upper holes, mark and drill (2) 5/16" holes into the firewall (See Photo 5, below).
4. Drill out lower mounting hole to 3/8" (See Photo 6, below). **NOTE:** This is the factory "third" bolt that retains the OEM evaporator case.
5. Install Dynamat or equivalent insulation onto firewall (See Photo 7, below).

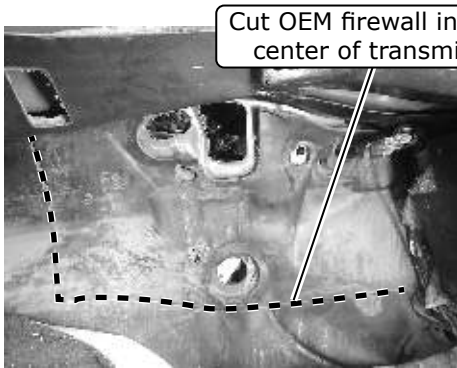

Cut OEM firewall insulation approximately from center of transmission tunnel, then remove

Photo 1



Place template inside on firewall over factory openings

Firewall Cover Template 644323

Photo 2

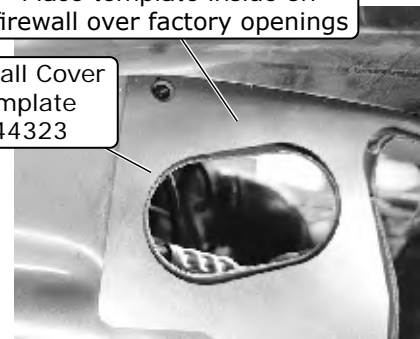
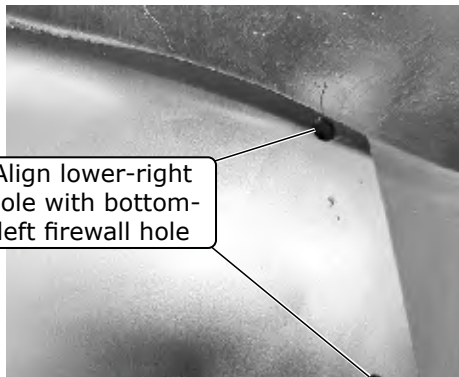

Photo 3



Align lower-right hole with bottom-left firewall hole

Photo 4



Mark and drill (2) 5/16" holes into firewall

Photo 5

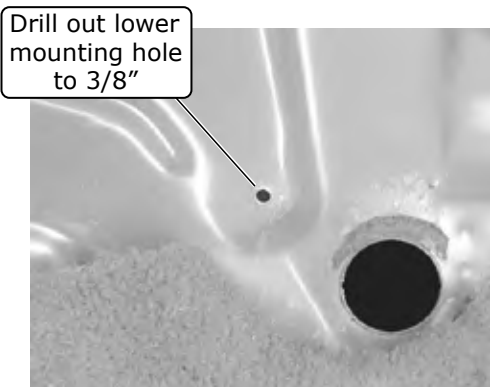

Drill out lower mounting hole to 3/8"

Photo 6

Install Dynamat or equivalent insulation onto firewall

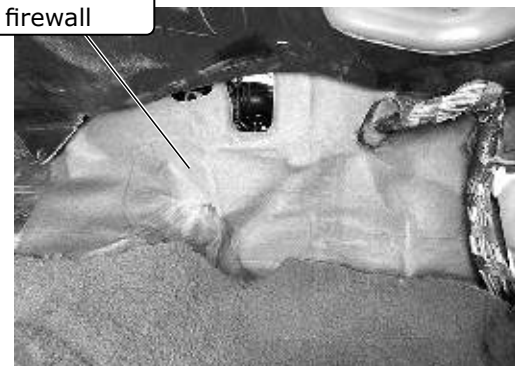

Photo 7



www.vintageair.com

Firewall Modification and Insulation (Cont.)

6. Cut all mounting holes through Dynaliner (See Photo 8, below).
7. Remove retainers, if present, and pull down the plastic cowl cover from the passenger side of the dash cowl.
8. Place the passenger-side fresh air cap over the opening for the fresh air vent. Mark and drill (4) pilot holes (See Photo 9, below).
9. Apply silicone or seam sealer onto the holes (See Photo 10, below).
10. Apply a 1/4" bead of silicone or seam sealer around the mating surface of the passenger-side fresh air cap (See Photo 11, below).
11. Using (4) #10 x 1/2" sheet metal screws, attach the passenger-side fresh air cap to the vent opening on the cowl (See Photo 12, below).



Photo 8

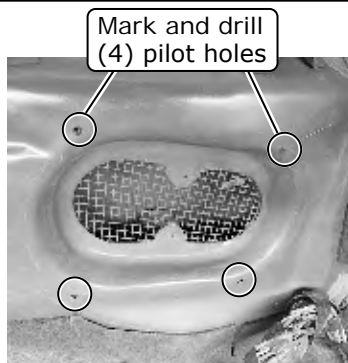

Photo 9

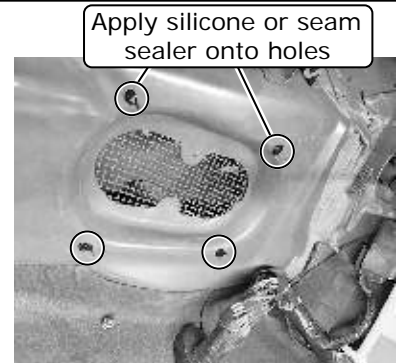

Photo 10

Apply a 1/4" bead of silicone or seam sealer around mating surface of passenger-side fresh air cap

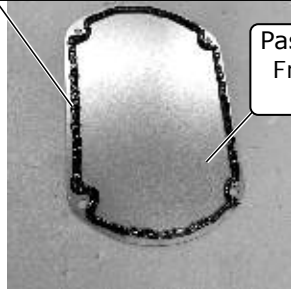

Photo 11

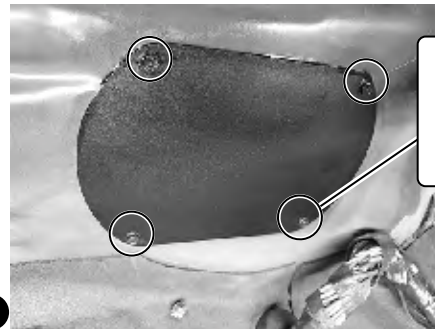

Photo 12

Properly Seated O-ring Land

When installing a hardline or A/C hose fitting onto the evaporator module, ensure the O-ring land is seated properly (See Photo 1, below). An improperly seated O-ring land (See Photo 2, below) can cause a leak. To properly install the fitting, slide the hardline or A/C hose nut back to expose the O-ring land and seat it onto the evaporator module fitting. Then, slide the hardline or A/C hose nut forward and thread it onto the evaporator module fitting, ensuring the O-ring land does not move or lift.

Properly Seated O-ring Land



Photo 1

Improperly Seated O-ring Land



Photo 2

NOTE: Photos shown are for reference only. Fittings may vary depending on kit received.



www.vintageair.com

Lubricating O-rings

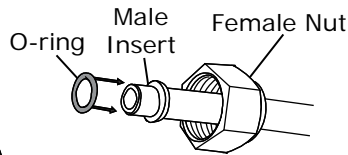
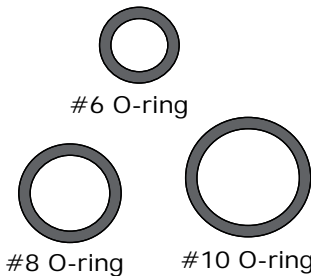

For a proper seal of fittings: Install supplied O-rings as shown and lubricate with refrigerant oil.

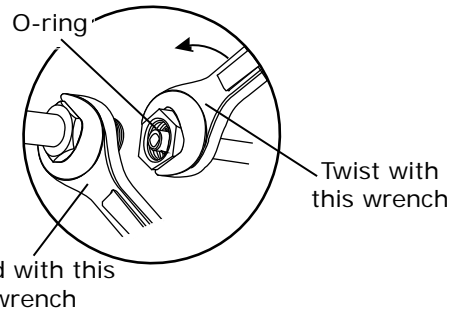
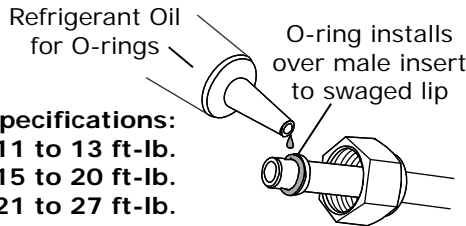

NOTE: Standard torque specifications:
 #6: 11 to 13 ft-lb.
 #8: 15 to 20 ft-lb.
 #10: 21 to 27 ft-lb.

Evaporator Preparation

NOTE: Ensure hardlines are aligned before fully tightening. Use a back-up wrench when tightening fittings. For all mounting provisions not being used, install the supplied caps.

Perform the following on a workbench:

1. With a properly lubricated #10 O-ring (See Lubricating O-rings, above), install the shorter heater hardline onto the evaporator module upper connection. Tighten until snug. (See Photo 1, below).
2. With a properly lubricated #10 O-ring (See Lubricating O-rings, above), install the longer heater hardline onto the evaporator module lower connection. Tighten until snug. (See Photo 2 below).
3. Install (3) 1/2" plastic plugs into the back of the evaporator case (See Photo 3, below). **NOTE: These mounting provisions will not be used in this application.**
4. Using (4) #10 x 5/8" screws, secure the evaporator firewall bracket assembly onto the evaporator (See Photos 4 and 5, below).

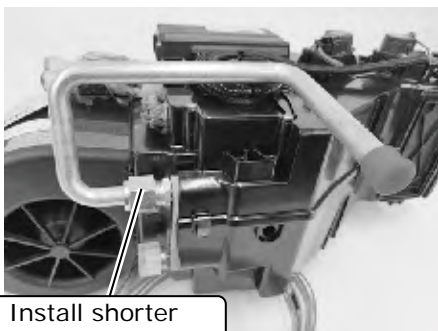

Install shorter heater hardline onto evaporator module upper connection

Photo 1



Install longer heater hardline onto evaporator module lower connection

Photo 2

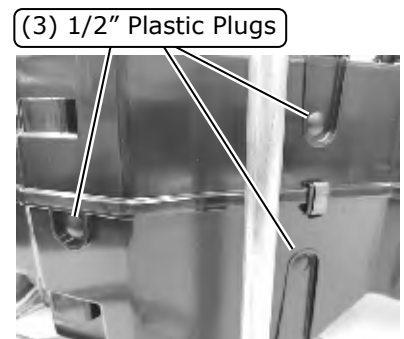

(3) 1/2" Plastic Plugs

Photo 3

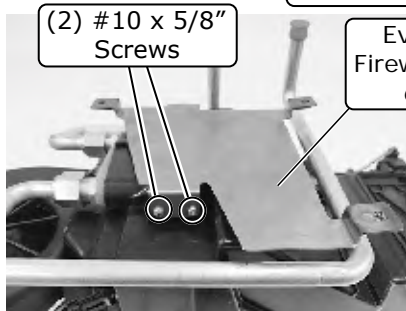

(2) #10 x 5/8" Screws

Evaporator Firewall Bracket 644308

Photo 4

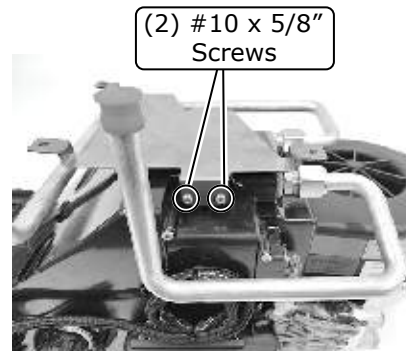

(2) #10 x 5/8" Screws

Photo 5



www.vintageair.com

Evaporator Preparation (Cont.)

5. Install (2) 1/4-20 x 1 3/4" studs, an 1/8" into the evaporator firewall bracket, in the locations shown in Photo 6, below. **NOTE: Install the studs with the Allen side facing out as shown in Photo 7, below.**
6. Temporarily install the firewall cover onto the evaporator firewall bracket assembly as shown in Photo 8, below. Secure it with (2) 1/4-20 nuts with star washers (See Photo 8, below).
7. Using the holes in the firewall cover, align the heater hardlines with the center of the holes (See Photo 8, below), then fully tighten them using a backup-wrench.
8. Once the hardlines are centered, remove the firewall cover.
9. Using (4) spring clips, install the dash plenum as shown in Photos 9 and 10, below.
10. Using (2) spring clips, install the floor plenum onto the back of the evaporator as shown in Photo 11, below.
11. Using (2) spring clips, install the 2-vent plenum onto the front of the evaporator as shown in Photo 12, below.
12. Using (2) 1/4-20 well-nuts and (2) 1/4-20 x 1" serrated flange bolts, secure the cowl bracket to the front of the evaporator case as shown in Photos 13 and 14, below.

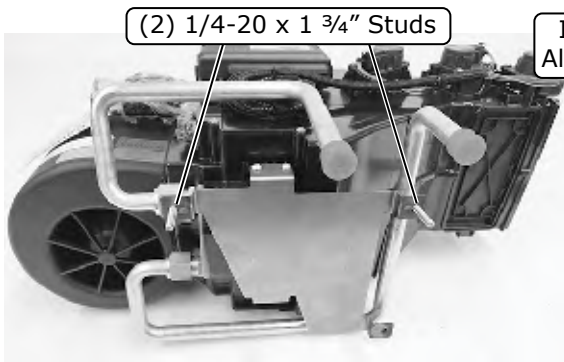

Photo 6



Photo 7

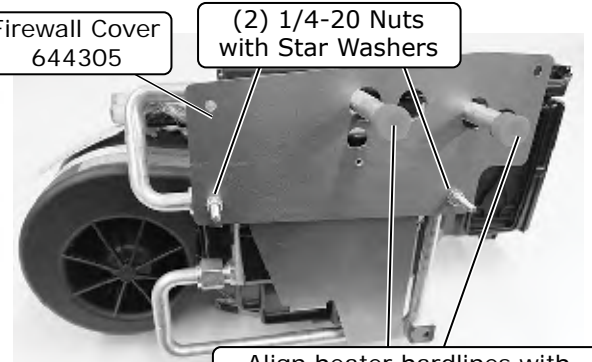

Photo 8

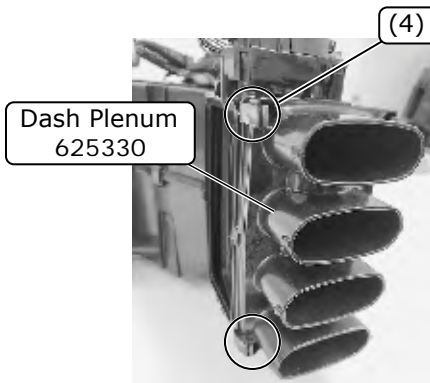

Photo 9

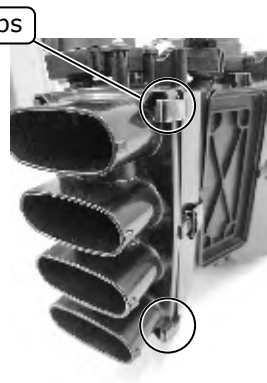

Photo 10

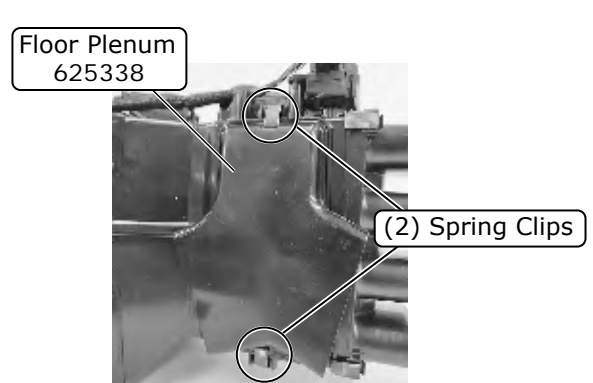

Photo 11

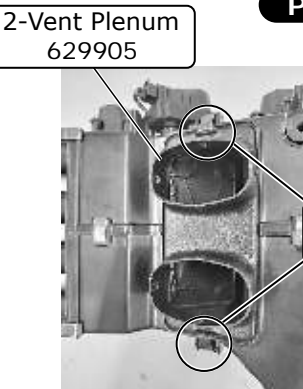

Photo 12

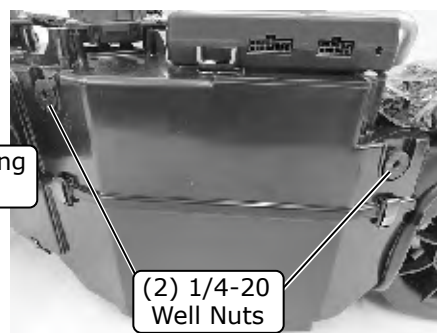

Photo 13

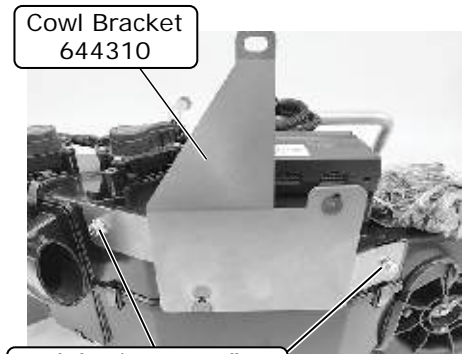

Photo 14



www.vintageair.com

Evaporator Preparation (Final)

13. Remove the ECU from the location on top of the evaporator by loosening the (2) screws on top of the unit, then sliding the ECU off (See Photo 15, below).
14. Retighten the screws on the top of the unit (See Photo 16, below).
15. Install the ECU onto the front of the dash evaporator bracket using (2) 10-24 x 1/4" pan head screws (See Photo 17, below).
16. Secure the wire harness using tie wraps (See Photo 18, below).



Photo 15

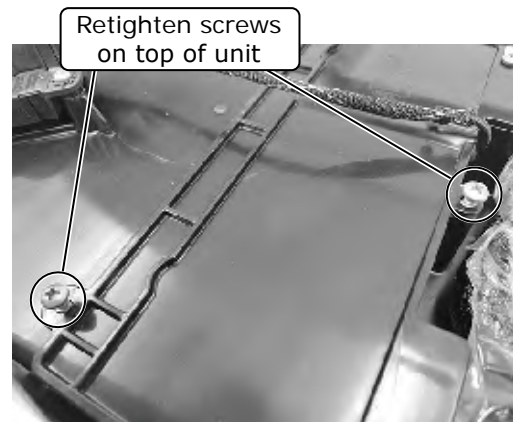

Photo 16

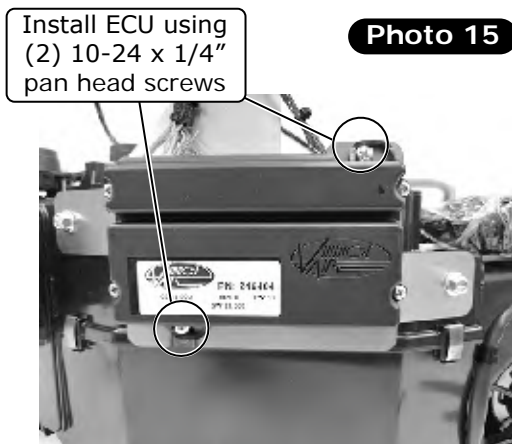

Photo 17

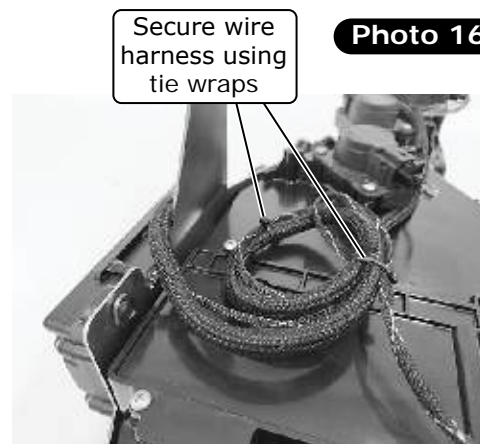

Photo 18



www.vintageair.com

Firewall Cover Preparation and Installation

Perform the following on a workbench:

1. Place the firewall cover on top of the rubber boot as shown in Photo 1, below. **NOTE: The press nut should be against the rubber boot.**
2. Push (2) 1/4-20 x 1" black serrated flange bolts through the upper holes of both parts (See Photo 2, below), then secure using (2) 1/4" pushnut bolt retainers (See Photo 3, below).
3. From the back side, push the #10 A/C evaporator/bulkhead hose bulkhead fitting through the rubber boot and firewall cover (See Photo 4, below)
4. Using the captured O-ring, thread the nut down onto the firewall cover, then tighten (See Photos 5 and 6, below).
5. Install the firewall cover assembly onto the firewall, then loosely secure the upper bolts from the passenger compartment with 1/4-20 nuts with star washers (See Photo 7, below)
6. Loosely thread the (2) lower 1/4-20 x 1" black serrated flange bolts into the firewall cover to align. Tighten the upper nuts with star washers from the passenger compartment, then remove the lower bolts.

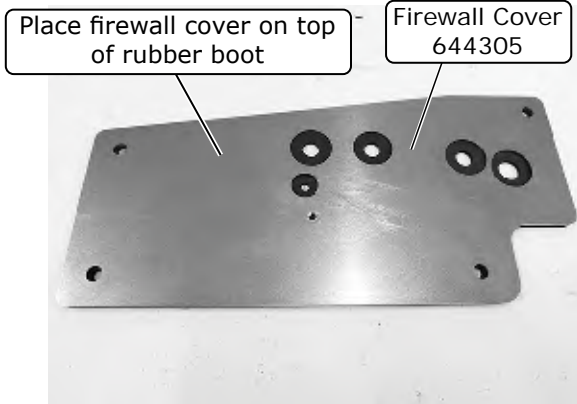

Photo 1

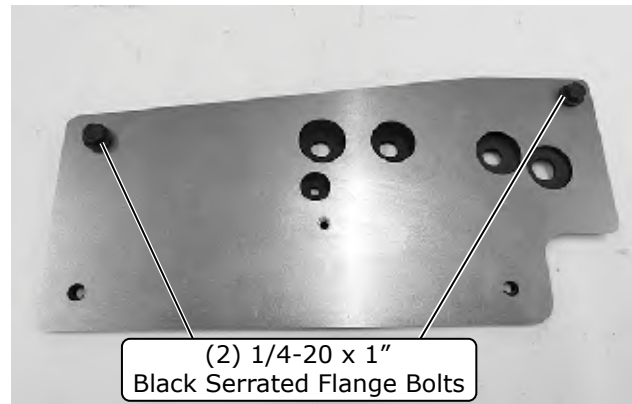

Photo 2

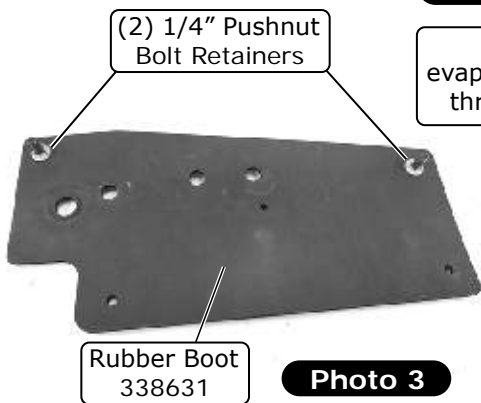

Photo 3



Photo 4



Photo 5

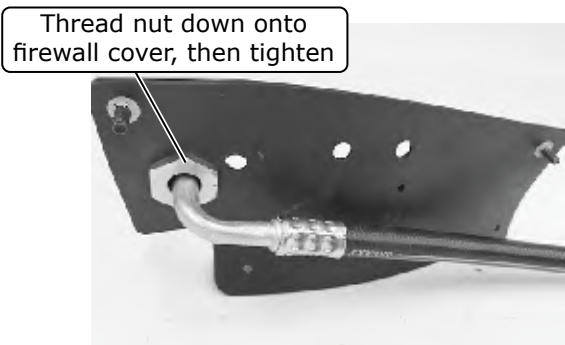

Photo 6

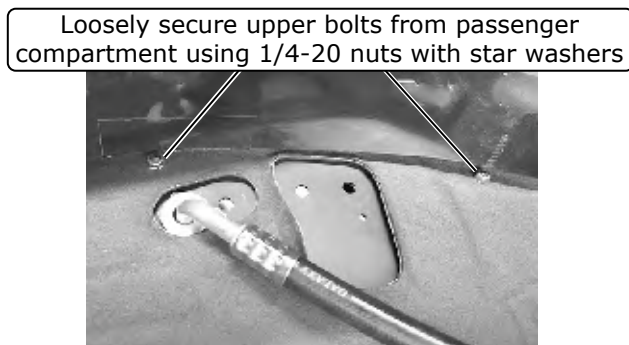

Photo 7



www.vintageair.com

Drain Hole Cover Installation

1. Install the cabin drain plate onto the studs of the assembly as shown in Figure 1, below. Secure with (2) 10-32 locknuts until flush with the studs.
2. Dry fit the assembly by sliding the plate into the large drain hole on the firewall, from the engine bay. The 5/8" drain hole should be oriented towards the 3 O'clock position as shown in Photo 1, below. **NOTE: The drain hose plate can be rotated depending on the exhaust manifold/header position.**
3. Verify fitment and clocking, then remove.
4. For the final installation, apply a bead of silicone or seam sealer around the mounting surface of the assembly, then install (See Figure 1, below).
5. From inside the passenger compartment, tighten both locknuts until the plates are secured (See Photo 1, below).

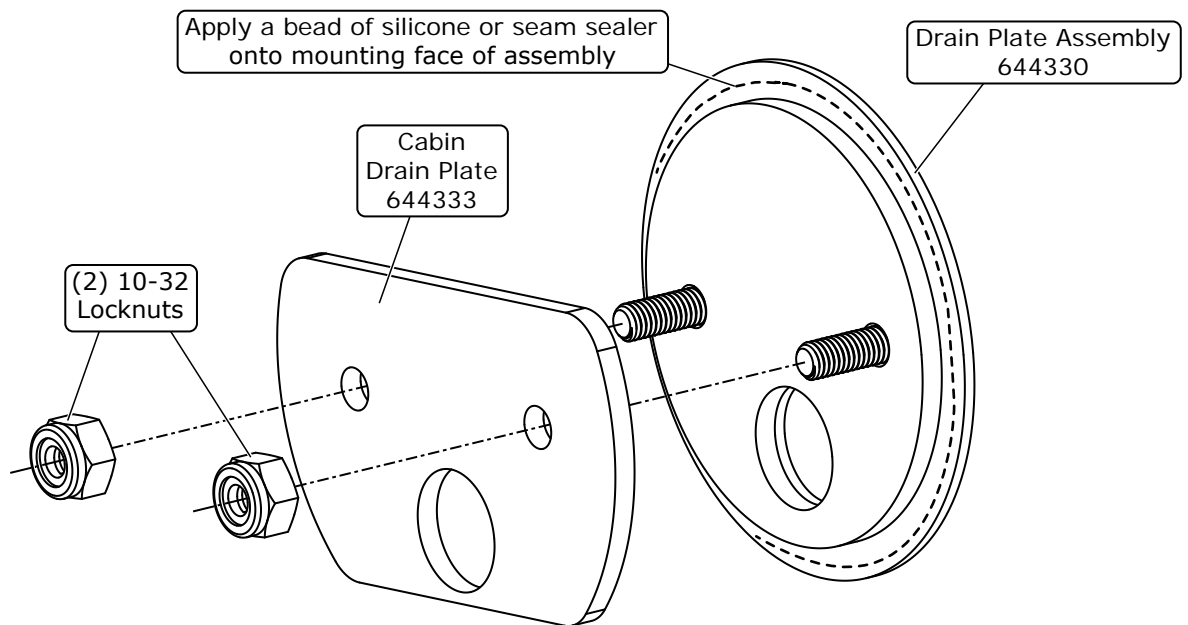

Figure 1

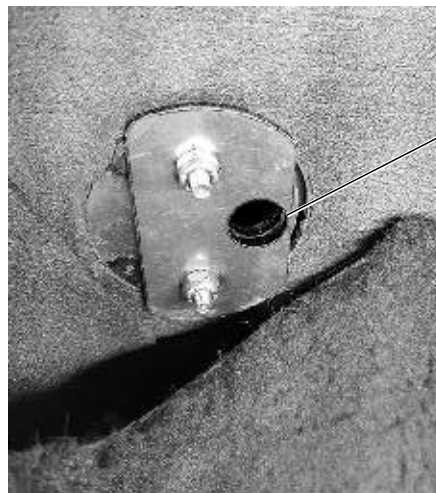

Photo 1



www.vintageair.com

Passenger Compartment Wiring

1. From the passenger compartment, route the heater control valve plug on the main wiring harness (white/yellow/purple) through the rubber boot and firewall cover (See Photos 1 and 2, below).
2. Route the red, white and blue wires from the main wiring harness through the firewall cover (See Photos 3 and 4, below). **NOTE: Leave approximately 16" of wiring between the relay and the firewall boot. This allows enough wiring to secure the relay to the mounting position.**
3. Select a suitable location for the main relay, then secure it using a #10 x 1/2" sheet metal screw (See Photo 5, below).
4. Select a suitable ground location for the white ground wire eyelet from the heater control valve harness, then secure it using a #12 self-tapping screw (See Photo 6, below).

Route heater control valve plug on main wiring harness (white/yellow/purple) through rubber boot and firewall cover

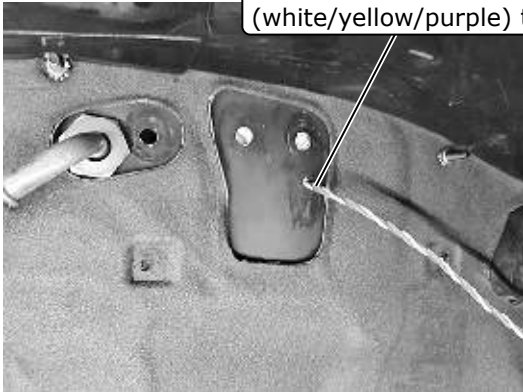

Photo 1



Photo 2

Route red, white and blue wires from main wiring harness through firewall cover

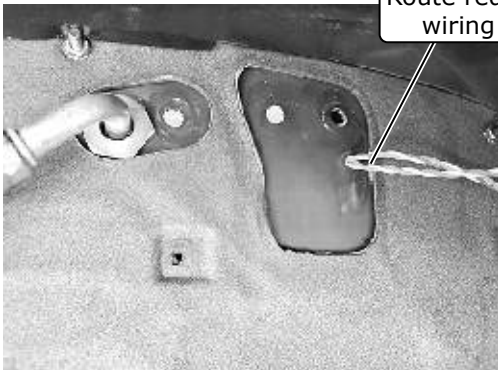

Photo 3



Photo 4

Secure main relay using #10 x 1/2" sheet metal screw

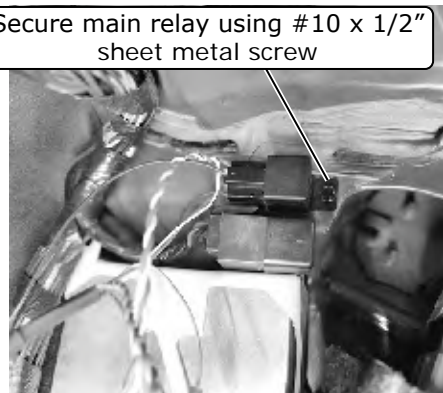

Photo 5

Secure white ground wire eyelet using a #12 self-tapping screw

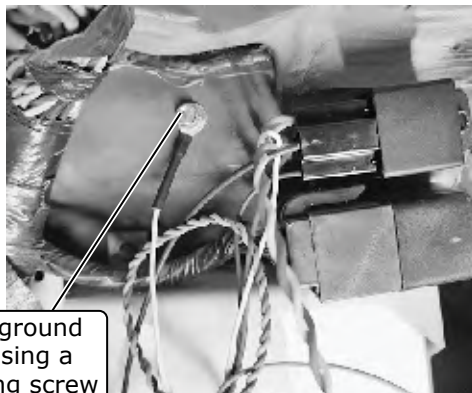

Photo 6



www.vintageair.com

Passenger Compartment Wiring (Cont.)

5. Secure the wires to the OEM wiring harness using (2) tie wraps (See Photo 7, below).
6. Place the evaporator assembly onto the passenger-side floorboard (See Photo 8, below).
7. Route the heavy gauge orange and white wires through the rubber boot and firewall cover (See Photos 9 and 10, below).
8. Replace the plastic cowl cover.

Secure wires to OEM wiring harness using (2) tie wraps

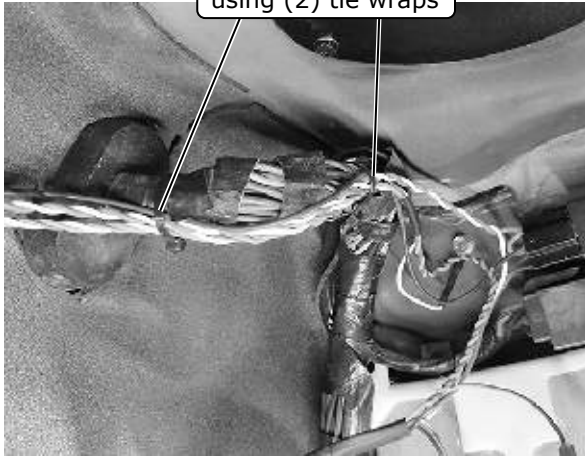

Photo 7

Place evaporator assembly onto passenger-side floorboard

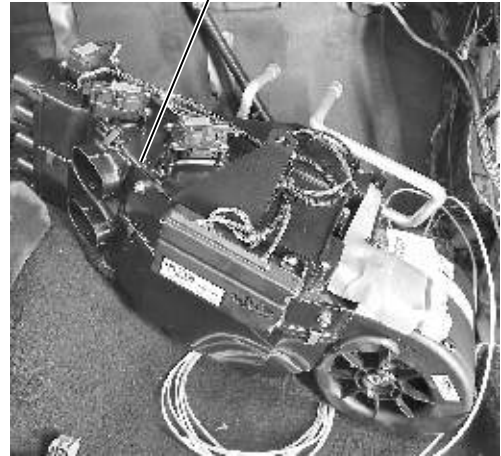

Photo 8

Route heavy gauge orange and white wires through rubber boot and firewall cover

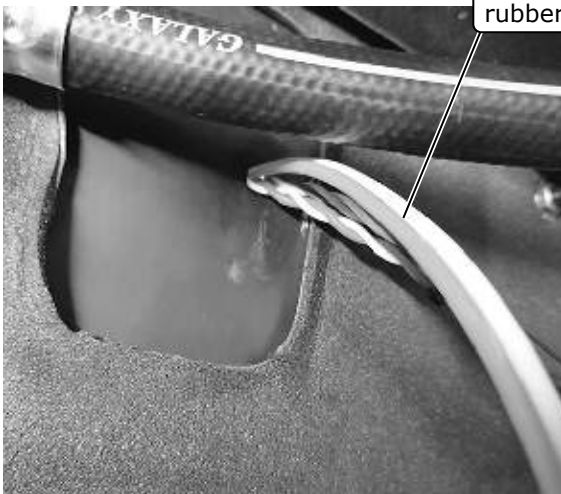

Photo 9



Photo 10



www.vintageair.com

Evaporator Installation

1. Lift the unit into place and push the (2) studs into the lower mounting holes of the firewall, through the rubber boot and firewall cover (See Photo 1, below).
2. Hang the unit with the dash bracket by securing it to the interior cowl using the OEM bolt threaded into the boss (See Photo 2, below).
3. Using soapy water, push the heater hardlines through the rubber boot (See Photo 3, below). **NOTE: Remove caps from heater lines before installation. Replace caps after installation is complete.**
4. From the engine bay, install the 1/4-20 x 3/4" serrated flange bolt into the lower evaporator mounting hole on the firewall and into the evaporator bracket (See Photo 4, below).
5. If the lower bolt is difficult to install, you may also install the 1/4-20 x 3/4" serrated flange bolt from the inside (See Photo 5, below), and secure it to the firewall using a 1/4-20 nut with star washer (See Photo 6, below).
6. One at a time, remove the (2) studs shown in Photo 1, below, and replace with 1/4-20 x 3/4" serrated flange bolts.

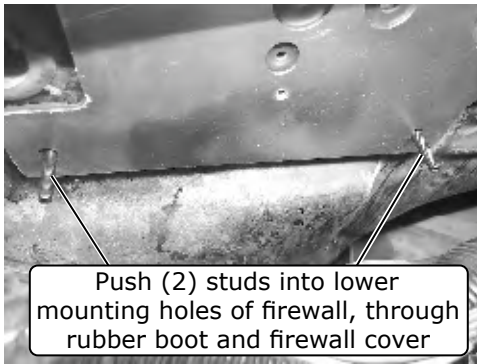

Photo 1

Secure unit with dash bracket to interior cowl using OEM bolt

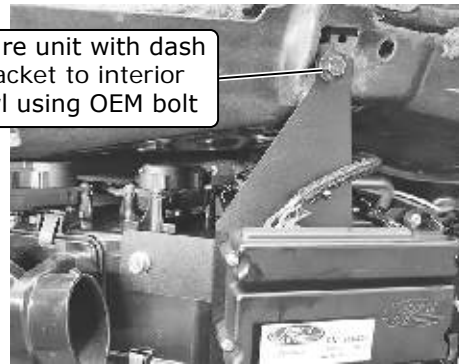

Photo 2

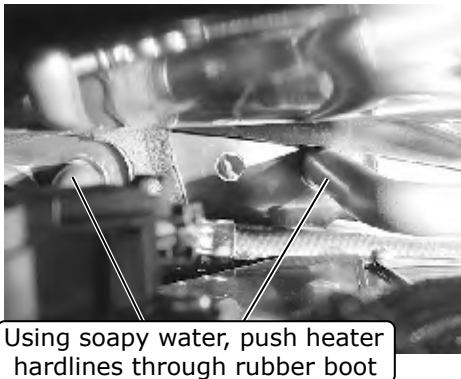

Photo 3

Install 1/4-20 x 3/4" serrated flange bolt into lower evaporator mounting hole on firewall

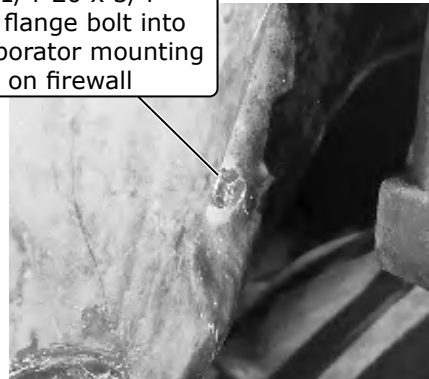

Photo 4

If lower bolt is difficult to install, install 1/4-20 x 3/4" serrated flange bolt from inside passenger compartment



Photo 5

Secure with 1/4-20 Nut with Star Washer

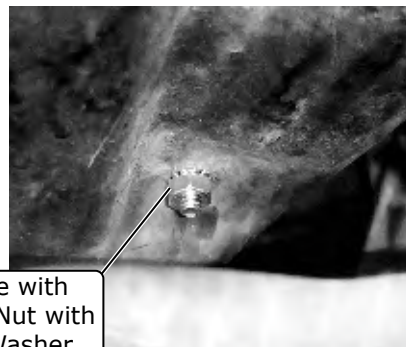

Photo 6



www.vintageair.com

Evaporator Installation (Cont.)

7. Inside the passenger compartment, verify the unit is level front to back and left to right (See Photos 7 and 8, below). Once leveled, fully tighten all (3) evaporator bracket bolts and the evaporator dash bolt.

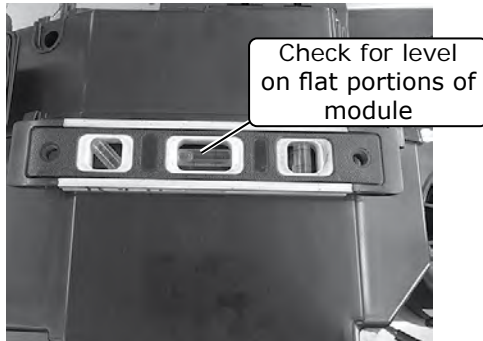

Photo 7

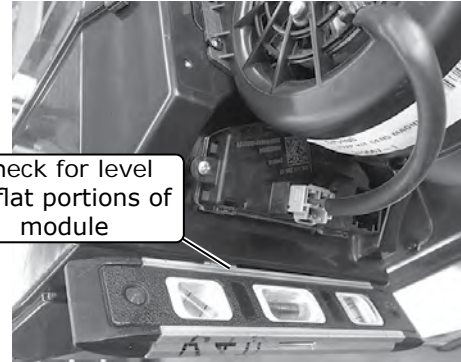

Photo 8

Drain Hose Installation

1. Cut the drain hose into 8 1/2" and 6 1/2" lengths (See Photo 1, below).
2. Install both pieces onto the supplied 1/2" drain elbow (See Photo 1, below).
3. From the engine bay, push the 8 1/2" piece of hose into the vehicle. The shorter 6 1/2" section of hose should be hanging down and can be trimmed as needed (See Photo 2, below).
4. Inside the car, push the drain hose onto the drain nipple of the evaporator module (See Photo 3, below).

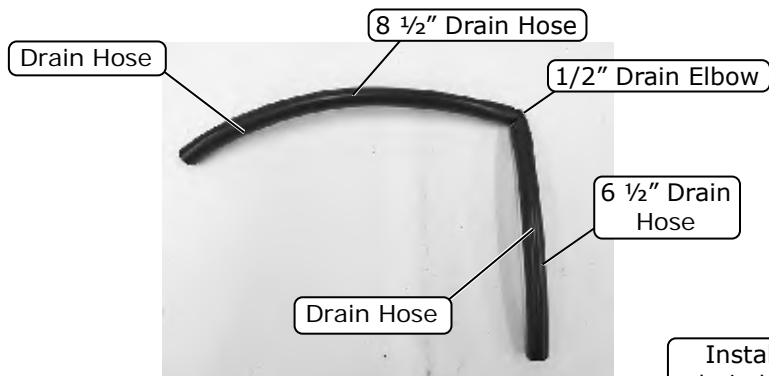

Photo 1

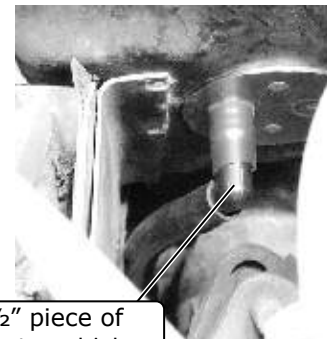

Photo 2

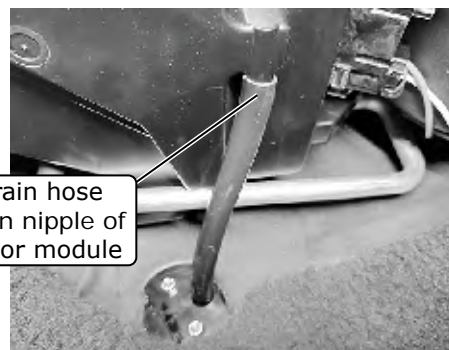

Photo 3



www.vintageair.com

A/C Hose Installation

1. Feed the straight fitting of the #6 drier/evaporator A/C hose (from the passenger compartment to the engine compartment), through the firewall and rubber boot (See Photo 1, below).
2. Remove the smaller cap from the evaporator block fitting and the cap from the #6 A/C hose.
3. With a properly lubricated #6 O-ring (See Lubricating O-rings, Page 15), install the 135° fitting of the #6 A/C hose onto the evaporator block fitting (See Photo 2, below). Tighten until snug.
4. Remove the larger cap from the evaporator block fitting and the cap from the #10 hose.
5. With a properly lubricated #10 O-ring (See Lubricating O-rings, Page 15), install the 90° fitting of the #10 evaporator/bulkhead A/C hose onto the evaporator block fitting (See Photo 3, below). Tighten until snug.
6. Once both fittings are connected and aligned as shown in Photo 3, below, fully tighten both fittings.
7. Wrap the #10 A/C hose fitting at the evaporator with press tape (See Photo 4, below).
8. Route the #6 A/C hose toward the condenser hardlines. With a properly lubricated #6 O-ring (See Lubricating O-rings, Page 15), install the hose onto the #6 condenser hardline, then tighten (See Photo 5, below).
9. Secure the #6 A/C hose to the shock tower using an Adel clamp and a 10-32 x 3/4" screw and nut with star washer as shown in Photo 6, below.
10. Using a properly lubricated #10 O-ring (See Lubricating O-rings, Page 15), loosely connect the #10 bulkhead/compressor A/C hose 90° fitting with service port to the compressor (See Photo 7, below).



Feed straight fitting of #6 A/C hose through firewall and rubber boot

Photo 1

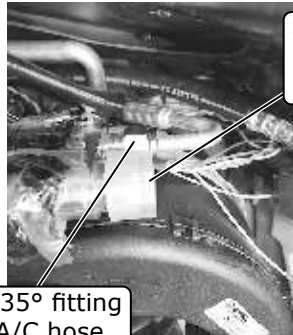

Install 135° fitting of #6 A/C hose

Photo 2

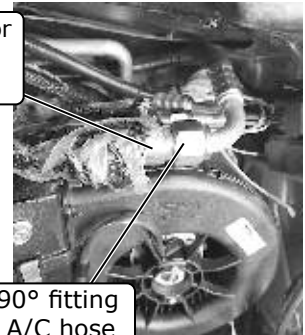

Install 90° fitting of #10 A/C hose

Photo 3

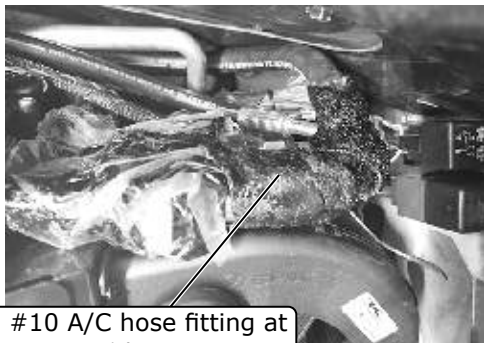

Wrap #10 A/C hose fitting at evaporator with press tape

Photo 4



Install #6 A/C hose to #6 condenser hardline and tighten

Photo 5

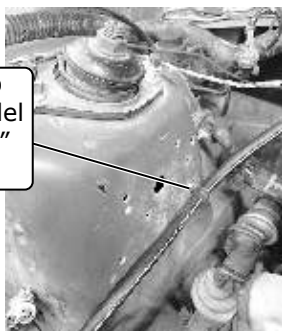

Secure #6 A/C hose to shock tower using an Adel clamp and 10-32 x 3/4" nut with star washer

Photo 6

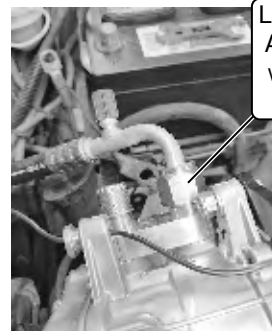

Loosely connect #10 A/C hose 90° fitting with service port to compressor

Photo 7



www.vintageair.com

A/C Hose Installation (Cont.)

11. Route the #10 A/C hose along the rear of the engine bay toward the bulkhead fitting (See Photo 8, below).
12. Using a properly lubricated #8 O-ring (See Lubricating O-rings, Page 15), loosely connect the #8 A/C hose 90° fitting with service port to the compressor (See Photo 9, below).
13. Route the #8 A/C hose along the #10 A/C hose toward the cover plate, then along the #6 A/C hose toward the condenser hardlines.
14. Using a properly lubricated #8 O-ring (See Lubricating O-rings, Page 15), connect straight fitting to the #8 hardline and tighten (See Photo 10, below).
15. Using a properly lubricated #10 O-ring (See Lubricating O-rings, Page 15), connect the #10 A/C hose 90° fitting to the bulkhead fitting (See Photo 11, below).
16. Ensure all fittings are tight at this time.

Route #10 A/C hose
along rear of engine bay
toward bulkhead fitting

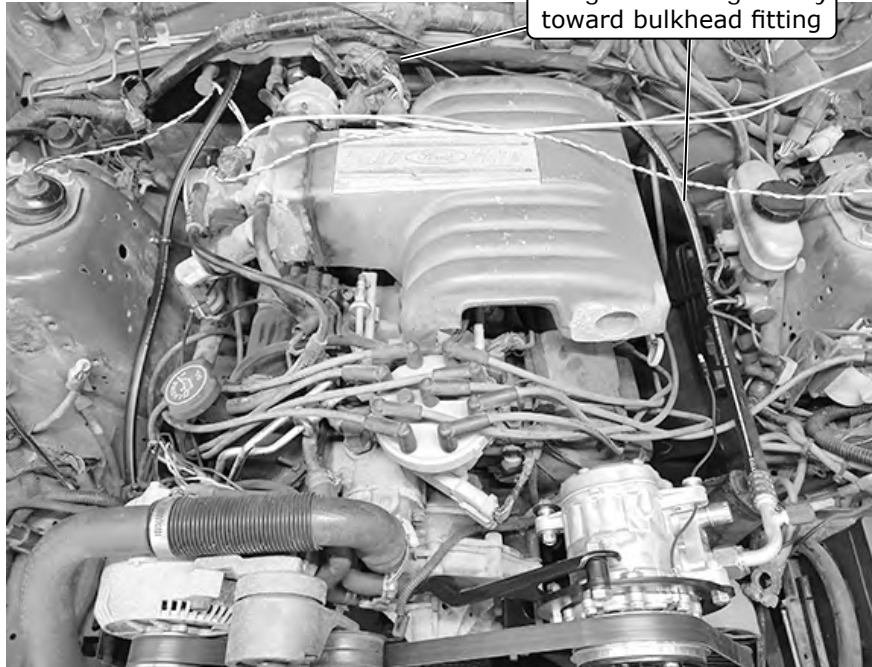

Photo 8

Loosely connect #8 A/C
hose 90° fitting with
service port to compressor



Photo 9

Connect straight
fitting of #8 A/C
hose to #8 hardline

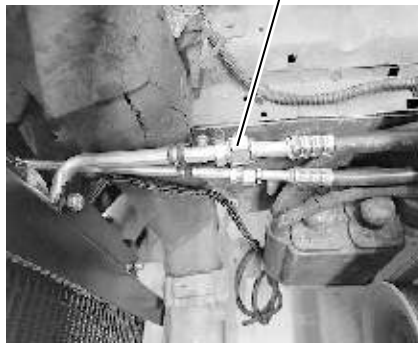

Photo 10

Connect #10 A/C hose
90° fitting to bulkhead
fitting

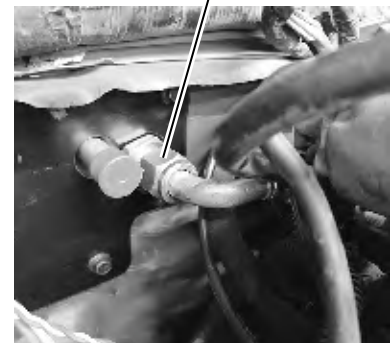

Photo 11



www.vintageair.com

Heater Control Valve Preparation

NOTE: For 1986-93 factory 5.0 engines, Ford uses both 3/4" and 5/8" heater hardlines that run underneath the upper intake manifold. Vintage Air offers a Molded Hose Kit (545019) that provides a clean installation from these hardlines to the heater control valve and evaporator.

1. Using (2) #8 x 1/2" pan head screws, attach the heater control valve bracket onto the back of the heater control valve, with the mounting hole on top as shown in Photos 1 and 2, below.
2. Install a 4" length of 5/8" heater hose (See Photo 3, below) onto the inlet of the heater control valve (See Photo 4, below). Secure it with a hose clamp (See Photo 4, below). **NOTE: Ensure proper flow direction through the heater control valve. The flow direction follows the molded arrow on the valve (See Figure 1, below).**
3. Attach the supplied heater hardline to the straight section of the hose (See Photo 5, below). Secure it with a hose clamp (See Photo 5, below).
4. Cut 1" off both ends of a Dayco 80400 (099000) molded 90° hose (See Photo 6, below).



Photo 1

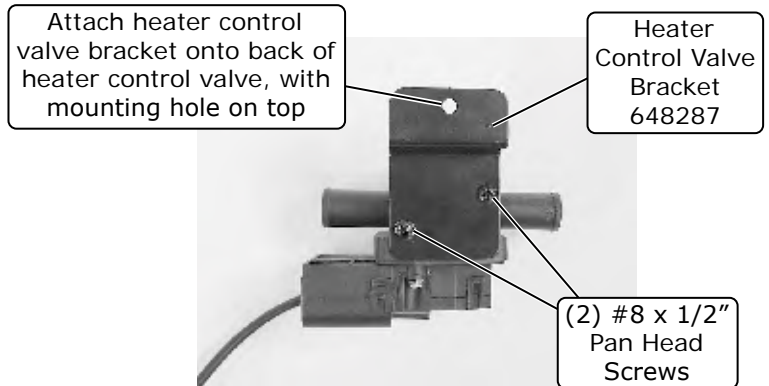

Photo 2

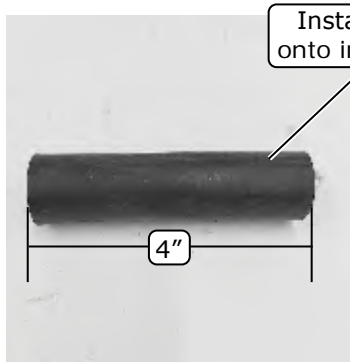

Photo 3

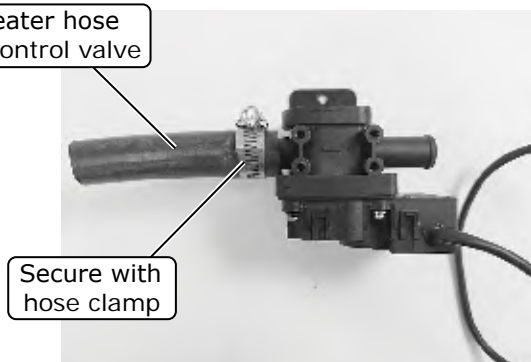

Photo 4

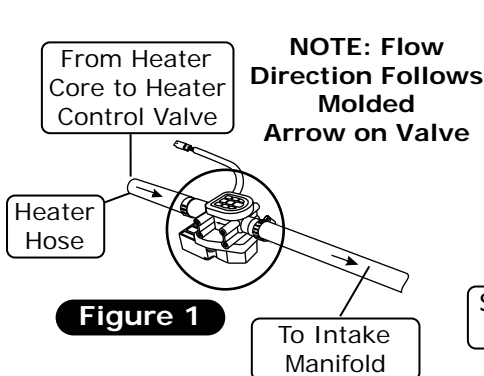

Figure 1

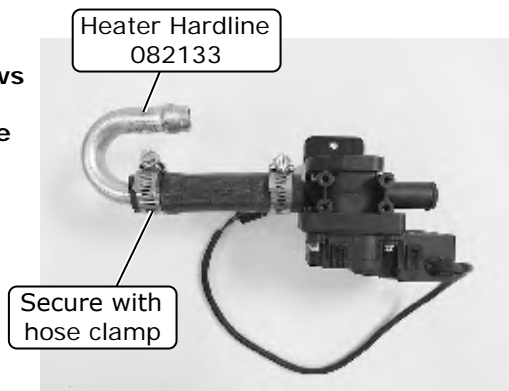

Photo 5

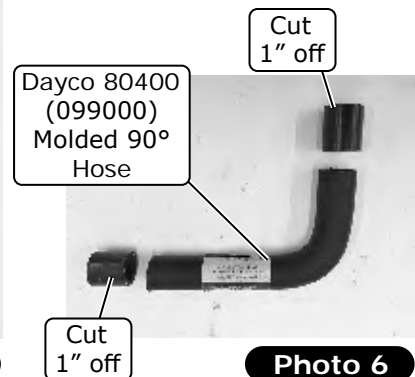

Photo 6



www.vintageair.com

Heater Control Valve Preparation (Cont.)

5. Install the longer end of the molded hose onto the heater hardline (See Photo 7, below). Secure with a hose clamp (See Photo 7, below).
6. Cut 1" off the shorter end of the other Dayco 80400 (099000) molded 90° hose for installation onto the engine hardline (See Photo 8, below).

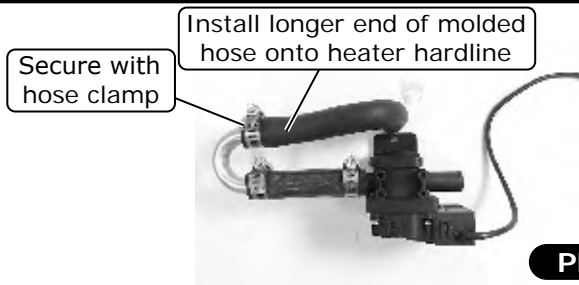

Photo 7

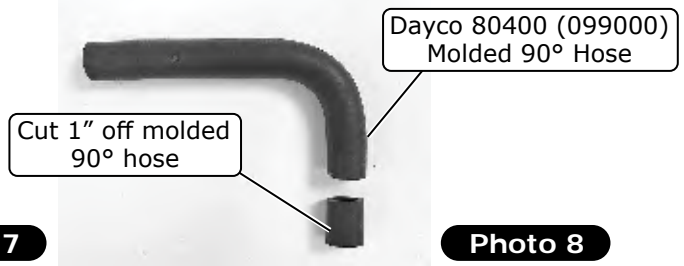

Photo 8

Heater Control Valve Installation

1. Install the 3/4" side of the Continental molded heater hose (63497) or equivalent onto the lower OEM heater hardline, then secure it with a hose clamp (See Photo 1, below).
2. Connect the 5/8" side of the Continental molded heater hose (63497) or equivalent onto the driver-side heater hardline that is coming through the firewall cover (See Photo 1, below). Secure it with a hose clamp (See Photo 1, below).
3. Install the pre-cut molded 90° hose onto the upper engine heater hardline and secure with a hose clamp (See Photo 2, below).
4. Install the heater control valve assembly's inlet to the passenger-side heater hardline coming from the evaporator (See Photo 3, below). Secure it with a hose clamp (See Photo 3, below).
5. If needed, trim the longer end of the molded 90° hose to fit the heater control valve assembly. Install the hose onto the heater control valve assembly and secure with a hose clamp (See Photo 4, below).

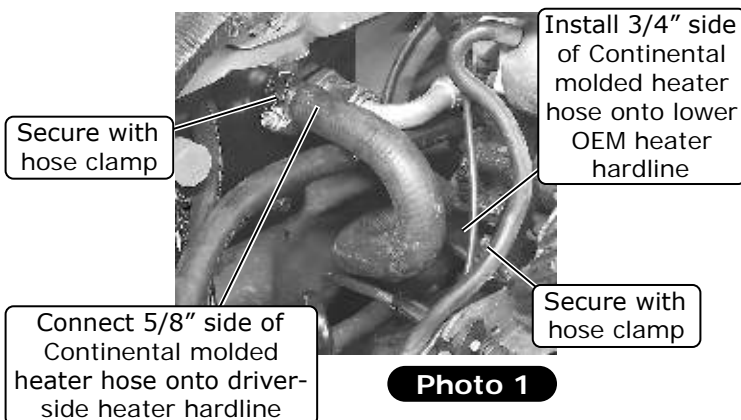

Photo 1

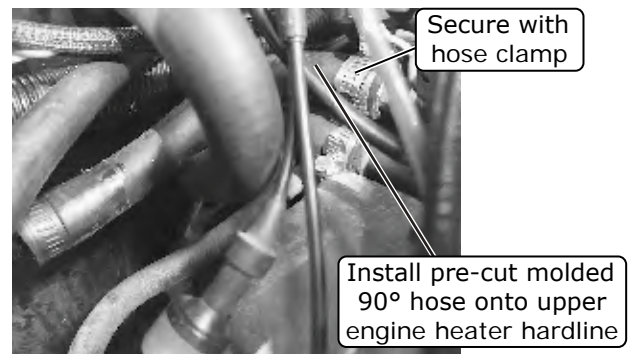

Photo 2

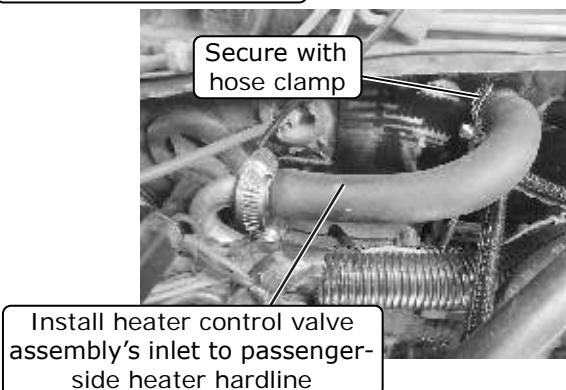

Photo 3

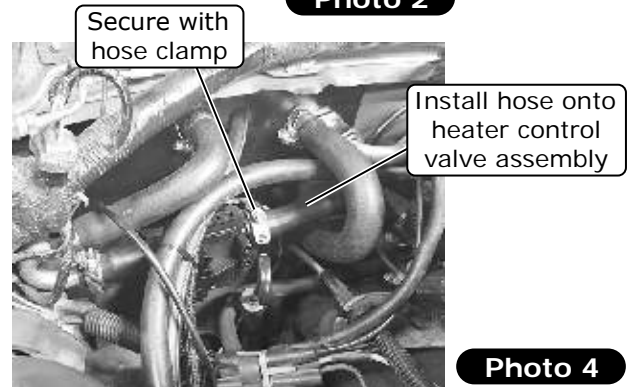

Photo 4



www.vintageair.com

Heater Control Valve Installation (Cont.)

- Secure the heater control valve bracket to the hole on the firewall cover using a 10-24 x 1/4" pan head screw as shown in Photo 5, below.
- Plug the heater control valve connector into the heater control valve connector wiring harness (See Photo 6, below).

Secure heater control valve bracket to hole on firewall cover using 10-24 x 1/4" pan head screw

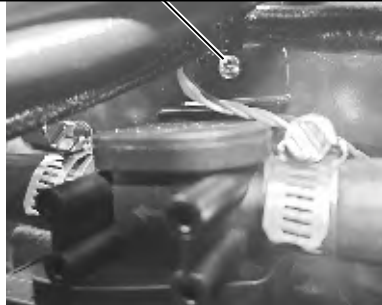

Photo 5

Plug heater control valve connector into heater control valve wiring harness

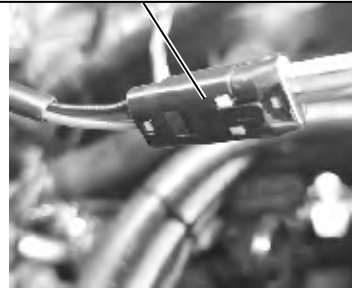

Photo 6

Dash Louver Adapter Preparation

Perform the following on a workbench:

- Remove the OEM hardware securing the factory passenger-side A/C plenum to the inner dash, then remove the plenum (See Photos 1, 2 and 3, below) (retain hardware).
- Remove the OEM sealing foam from the louver housing. Clean the housing and replace the OEM sealing foam with the supplied 3/8" x 1" polyurethane open cell foam (See Photo 4, below).

Remove OEM hardware securing factory passenger-side A/C plenum to inner dash, then remove plenum

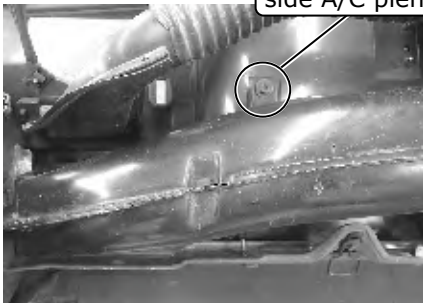

Photo 1

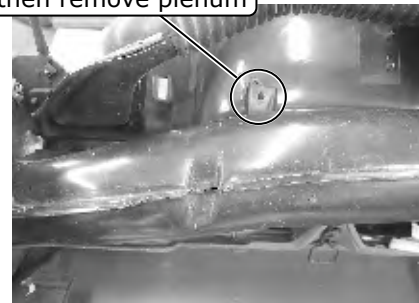

Photo 2

Remove OEM hardware securing factory passenger-side A/C plenum to inner dash, then remove plenum

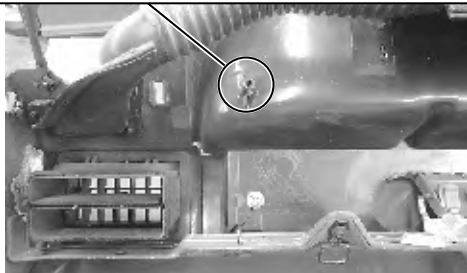

Photo 3

3/8" x 1" Polyurethane Open Cell Foam

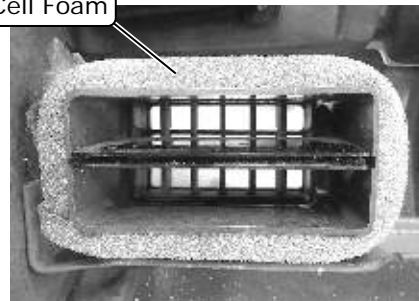

Photo 4



www.vintageair.com

Dash Louver Adapter Preparation (Cont.)

3. Apply silicone to the mating surface of the A/C plenum, then install the louver adapter (See Photos 5 and 6, below). Let the silicone cure.
4. Reinstall the A/C plenum onto the louver, then secure it with the OEM hardware (See Photo 7, below).
5. Repeat Steps 1-4 for the driver-side A/C plenum (See Photos 8, 9, 10, 11, 12 and 13, below).

Apply silicone to mating surface of A/C plenum, then install louver adapter

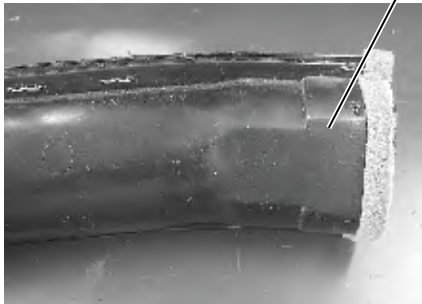
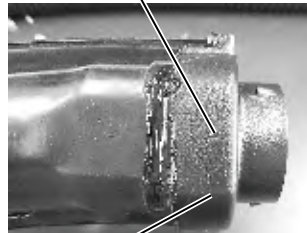

Photo 5



Passenger-Side Louver Hose Adapter 593017

Photo 6

Reinstall A/C plenum onto louver, then secure with OEM hardware

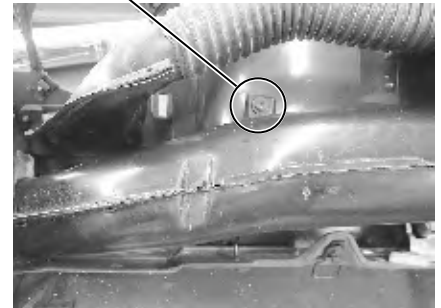

Photo 7

Remove OEM hardware securing factory driver-side A/C plenum to inner dash, then remove plenum

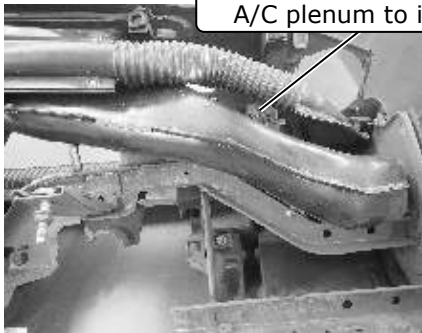

Photo 8



Photo 9

3/8" x 1" Polyurethane Open Cell Foam



Photo 10

Apply silicone to mating surface of A/C plenum, then install louver adapter

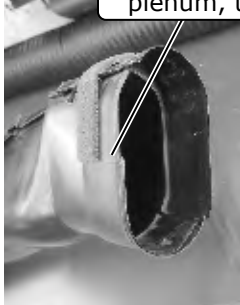
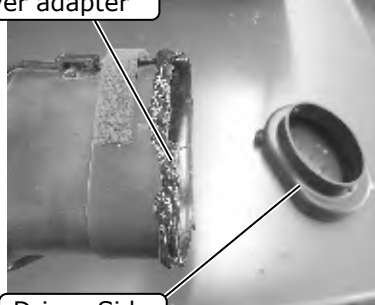

Photo 11



Driver-Side Louver Hose Adapter 593018

Photo 12

Reinstall A/C plenum onto louver, then secure with OEM hardware

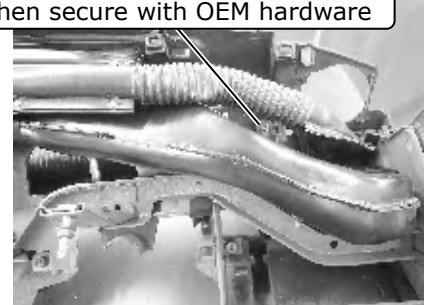

Photo 13



www.vintageair.com

Dash Louver Adapter Preparation (Final)

6. Remove the OEM sealing foam from the dual center louver (See Photo 14, below). Apply silicone to the mating surface (See Photo 14, below) and install the center louver hose adapter (See Photo 15, below). **NOTE: Before the silicone cures, activate the vent doors to ensure free travel (See Photo 16, below). Adjust the hose adapter if needed.**
7. Install a #8 J-nut onto the OEM defrost plenum (See Photo 17, below).
8. Apply the supplied 1/8" x 1/2" x 8" sealing foam to the mating surface of the defrost louver hose adapter (See Photo 18, below).
9. Install the defrost louver hose adapter and secure it using a #8 x 1/2" pan head screw (See Photo 19, below).

Remove OEM sealing foam. Apply silicone to mating surface.

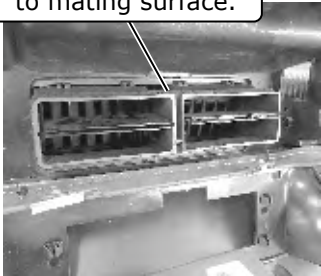

Photo 14

Center Louver Hose Adapter 593019

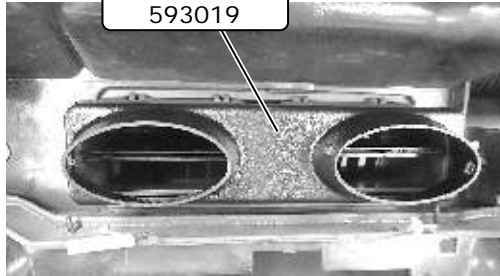

Photo 15

Test vent door operation

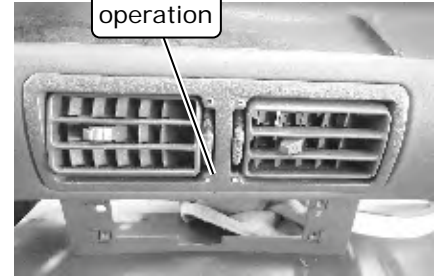

Photo 16

Install #8 J-nut onto OEM defrost plenum



Photo 17

1/8" x 1/2" x 8" Sealing Foam

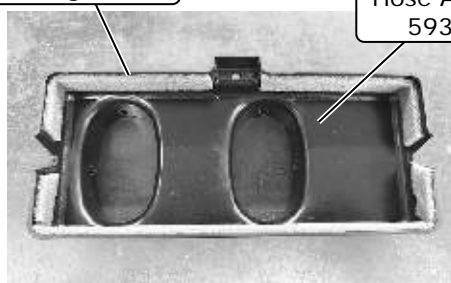

Photo 18

Defrost Louver Hose Adapter 593020

#8 x 1/2" Pan Head Screw

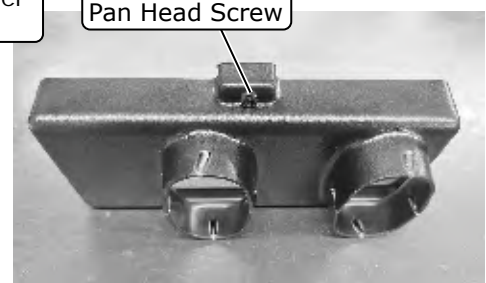

Photo 19



www.vintageair.com

Engine Compartment Wiring

1. Mark the blue compressor lead in the middle of the wire.
2. Using flexo sleeve, loom the blue lead from the halfway mark toward the bullet end, along with the red, orange and (2) white wires (See Photo 1, below).
3. Route the loomed wires under the #10 A/C hose toward the battery (See Photo 2, below).
4. The bullet connector end of the blue compressor lead should exit the loom and connect to the compressor clutch lead (See Photo 3, below).
5. Tie wrap the #8 A/C hose, #10 A/C hose, and wire loom together.
6. From the firewall cover, loom both blue wires with flexo sleeve, then route along the #6 hose toward the condenser.
7. Connect one blue wire to the white wire on the safety switch and the other blue wire to the brown wire (See Photo 4, below). Cut wire to length, then strip and crimp with butt connectors, using the supplied heat shrink.
8. Tie wrap loomed wires to the #6 and #8 A/C hoses.
9. Install the supplied heat shrink over the 12 AWG orange fuse holder assembly wire, and crimp it to the 12 AWG orange wire from the main wiring harness (See Photo 5, below, and Quality Crimp Guidelines, Page 38).

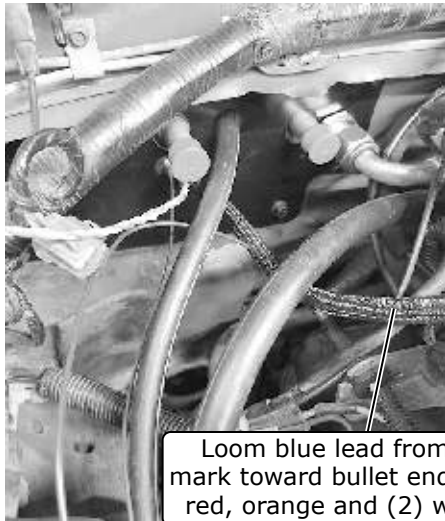

Loom blue lead from halfway mark toward bullet end along with red, orange and (2) white wires

Photo 1

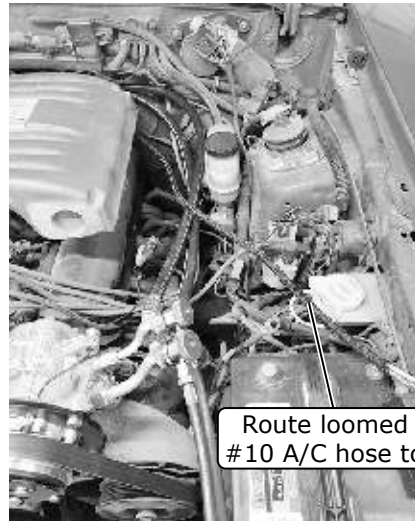

Route loomed wires under #10 A/C hose toward battery

Photo 2



Connect blue compressor lead to black compressor clutch lead

Photo 3

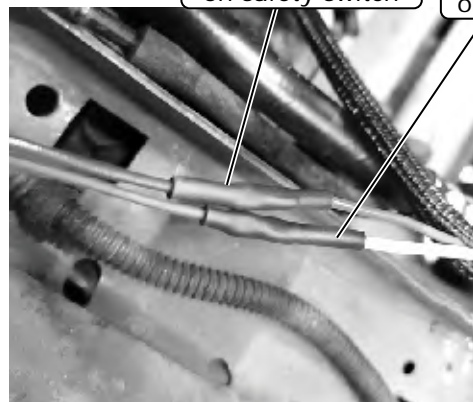

Connect one blue wire to brown wire on safety switch

Photo 4

Connect one blue wire to white wire on safety switch

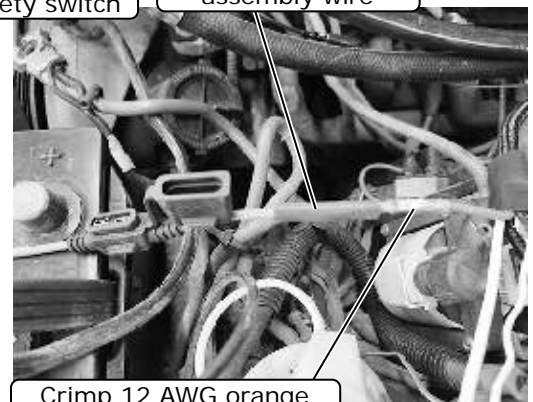

Install supplied heat shrink over 12 AWG orange fuse holder assembly wire

Crimp 12 AWG orange fuse holder assembly wire to 12 AWG orange wire from main wiring harness

Photo 5



www.vintageair.com

Engine Compartment Wiring (Cont.)

10. Install the supplied heat shrink over the 16 AWG black fuse holder assembly wire, and crimp it to the 16 AWG red wire from the main wiring harness (See Photo 6, below and Quality Crimp Guidelines, Page 38).
11. Install fuses into the holders (See Photo 7, below).
12. Install the supplied heat shrink over the white ground wires, then crimp on the supplied eyelets (See Photo 8, below and Quality Crimp Guidelines, Page 38).
13. Connect the ground wiring eyelets to the negative battery terminal connector.
14. Connect the positive wiring eyelets to the positive battery terminal connector. **NOTE: Do not connect power until installation is completed.**

Install supplied heat shrink over 16 AWG black fuse holder assembly wire



Photo 6

Install fuses into holders

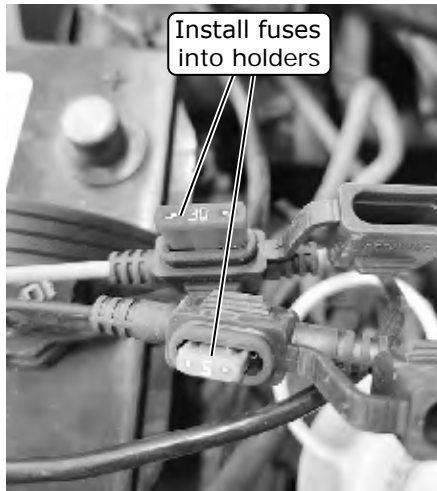

Photo 7

Install supplied heat shrink over white ground wires, then crimp on supplied eyelets

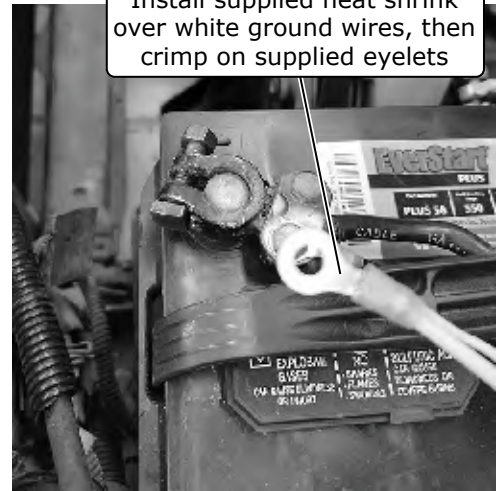

Photo 8

Passenger Compartment Wiring Final

1. Route the violet and tan wires over the evaporator unit, towards the center console.
2. Separate the previously identified OEM light blue/red and brown/orange wires (See Photo 1, below) (See Passenger Compartment Disassembly Step 8, Page 8).
3. Using the supplied butt connector and heat shrink, connect the violet wire to the previously identified OEM brown/orange striped wire (See Photo 2, below).
4. Using the supplied butt connector and heat shrink, connect the tan wire to the previously identified OEM light blue/red striped wires (See Photo 2, below). **NOTE: Some OEM control panel harnesses will have (2) light blue/red striped wires together at the same terminal. If so, connect the tan wire to both.**

OEM Brown/Orange Wire

OEM Light Blue/Red Wires

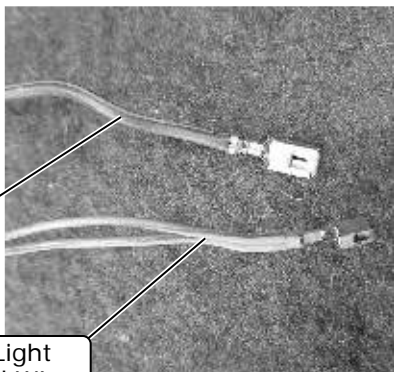

Photo 1

Using supplied butt connector and heat shrink, connect violet wire to OEM brown/orange striped wire

Using supplied butt connector and heat shrink, connect tan wire to OEM light blue/red striped wires

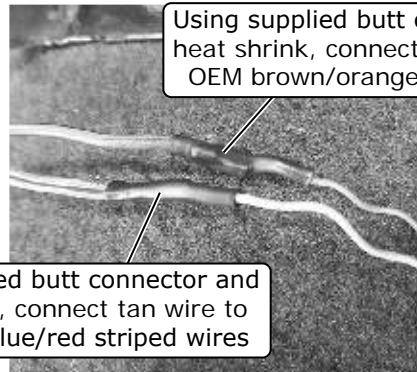

Photo 2



www.vintageair.com

Passenger Compartment Wiring Final (Cont.)

5. Connect the blower speed controller plug into the main wiring harness plug (orange and green wires) (See Photo 3, below).
6. Plug the main wiring harness into the ECU (See Photo 4, below).
7. Locate the fuse panel and remove the 30A fuse from location #9 (See Photo 5, below). Replace with supplied 5A fuse (See Photo 6, below). **NOTE: This is an OEM circuit dedicated to the A/C and heater blower motor.**

Connect blower speed controller plug into main wiring harness plug

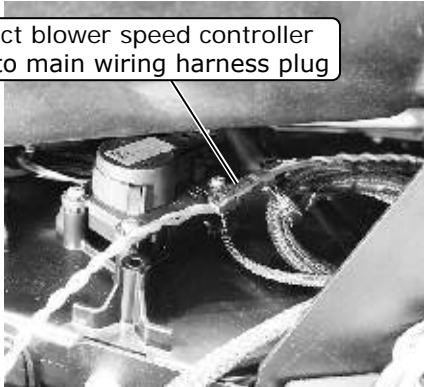
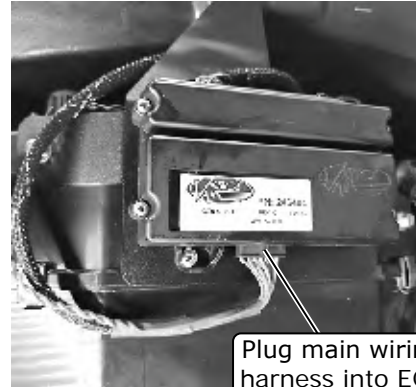

Photo 3



Plug main wiring harness into ECU

Photo 4

Remove 30A fuse from location #9

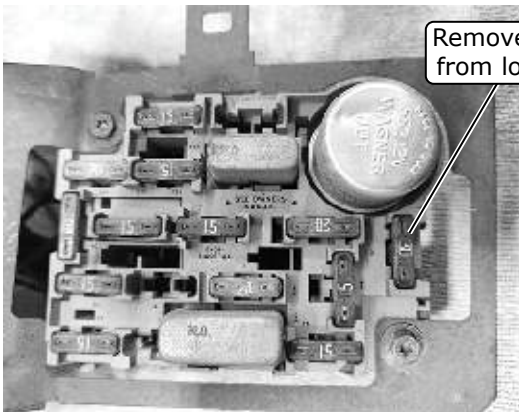

Photo 5

Replace 30A fuse with supplied 5A fuse

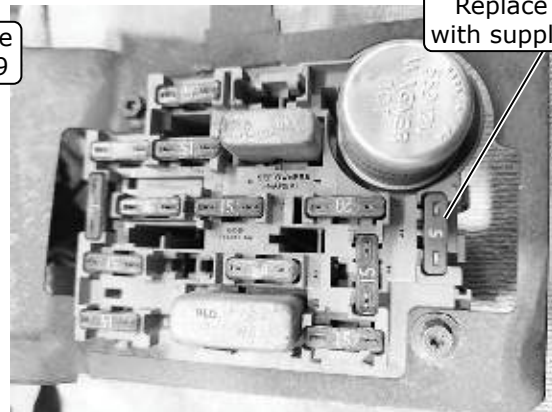

Photo 6

Dash Reassembly

1. Reinstall main dashboard assembly using original hardware.
2. Reconnect all factory wire harness connections and plugs.
3. Secure the fuse panel to the dashboard.



www.vintageair.com

Console Reassembly

1. Reinstall center console using factory hardware and brackets.
2. Reconnect all wiring connectors and bulbs.

Control Panel Installation

1. Refer to control panel instruction for installation procedures.

Passenger Compartment Reassembly

1. Reinstall radio, electrical connections, and trim/bezels.
2. Reinstall gauge cluster and all previously removed brackets, switches, electrical connections and trim pieces.
3. Reinstall remaining dash components, covers, brackets, switches, electrical connections, trim pieces, hood and trunk releases (if equipped).
4. Reinstall glove box.
5. Reinstall seats (if removed).

Engine Compartment Reassembly

1. Cap the OEM vacuum line on the firewall that operated the factory A/C (See Photo 1, below). **NOTE: For cleaner installation, it is optional to place the vacuum cap on the main vacuum tree (port marked A/C), then remove the vacuum line going across the firewall and the plastic vacuum check valve as shown in Photo 1, below.**
2. Reinstall any factory hoses, electrical connections, covers or components that may have been removed during installation.
3. Reconnect battery.

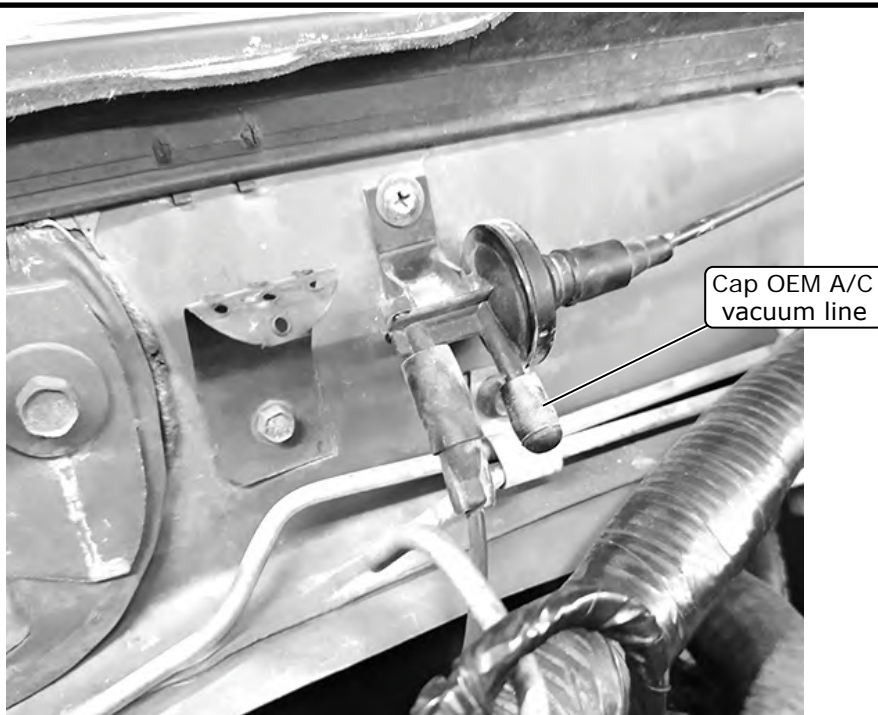
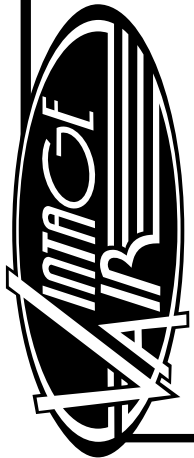

Photo 1



www.vintageair.com

Final Steps: Installation Check

Installation Check	
ITEM TO CHECK	Procedure
<input type="checkbox"/>	<p>ECU</p> <p>If no blinking is observed after 1 minute of turning the ignition on, go to the next check.</p> <p>If repetitive blinking is observed, go to the Advanced Diagnostics Section to diagnose.</p>
<input type="checkbox"/>	<p>Blower speed control</p> <p>Set the blower speed control to OFF, <u>confirm that the blower is off</u>.</p> <p>Position the blower speed control to LOW then MEDIUM and then HIGH. <u>At each setting confirm that the blower speed increases</u>, do this by feeling for the amount of air coming from the unit and hearing the blower speed increase.</p>
<input type="checkbox"/>	<p>Mode control</p> <p>Set the MODE control to the DASH position. <u>Confirm that air is being blown at the dash vents</u>.</p> <p>Set the MODE control to the FLOOR position. <u>Confirm that air is being blown at the floor vents</u>.</p> <p>Set the MODE control to the DEFROST position. <u>Confirm that all air is being blown from the defrost vents</u></p> <p>If heater lines are installed:</p> <p>Set the MODE control to the DASH position. Set the TEMP control to the MAX HEAT position. <u>Confirm that HOT air is coming from the dash vents</u>.</p>
<input type="checkbox"/>	<p>Temperature control</p> <p>If system is charged:</p> <p>Set the TEMP control to the MAX COOL position. <u>Confirm that COLD air is coming from the dash vents</u>.</p> <p>Also <u>confirm that the compressor "clicks" on</u> when adjusting the TEMP control from the MAX HEAT position to the MAX COOL position.</p>
<input type="checkbox"/>	<p>AC Indicator (If applicable)</p> <p>While the MODE control is set to the DASH position, and the TEMP control is set to the MAX COOL/MIN HEAT position, <u>confirm that the blue AC Indicator light is on</u>.</p>
<input type="checkbox"/>	<p>Backlight (If applicable)</p> <p>If your control panel has backlight capabilities and has been wired, turn the dash lamp on and <u>confirm that the AC panel's legend is lit</u>.</p>
<input type="checkbox"/>	<p>Fittings</p> <p>Verify AC and Heater fittings are all tight.</p>



www.vintageair.com

Final Steps: Completing the Install

1. Fill radiator with at least a 50/50 mixture of approved antifreeze and distilled water. It is the owner's responsibility to keep the freeze protection at the proper level for the climate in which the vehicle is operated. Failure to follow antifreeze recommendations will cause heater core to corrode prematurely and possibly burst in A/C mode and/or freezing weather, voiding your warranty.
2. Double check all fittings, brackets and belts for tightness.
3. Vintage Air recommends that all A/C systems be serviced by a licensed automotive A/C technician.
4. Evacuate the system for a minimum of 45 minutes prior to charging, and perform a leak check prior to servicing.
5. Charge the system to the capacities stated on Page 4 of this instruction manual.
6. See Operation of Controls procedures on Page 41.



www.vintageair.com

ECU, Control Panel & Duct Hose Routing

NOTE: For the system to function optimally, the duct hoses must be routed as directly as possible, taking care to avoid kinks, sharp bends and unnecessary length. Vintage Air supplies duct hoses in continuous lengths that will need to be cut to size depending on application. Before cutting, familiarize yourself with the installation instructions and verify the routing will work with your application. For custom hose routing, additional hose may be needed and can be purchased from Vintage Air.

1. Stretch the duct hose until there is no slack, measure, mark and cut hose to size (See Photo 1, below).
2. Refer to Figure 1, below, for duct hose routing.
3. Attach 30" of 2 1/2" duct hose to each hose adapter and connect to the evaporator as shown in Figure 1, below.

Stretch, measure, mark and cut hose to size



Photo 1

Disclaimer: Before cutting duct hose to length, verify the routing will work for your application.

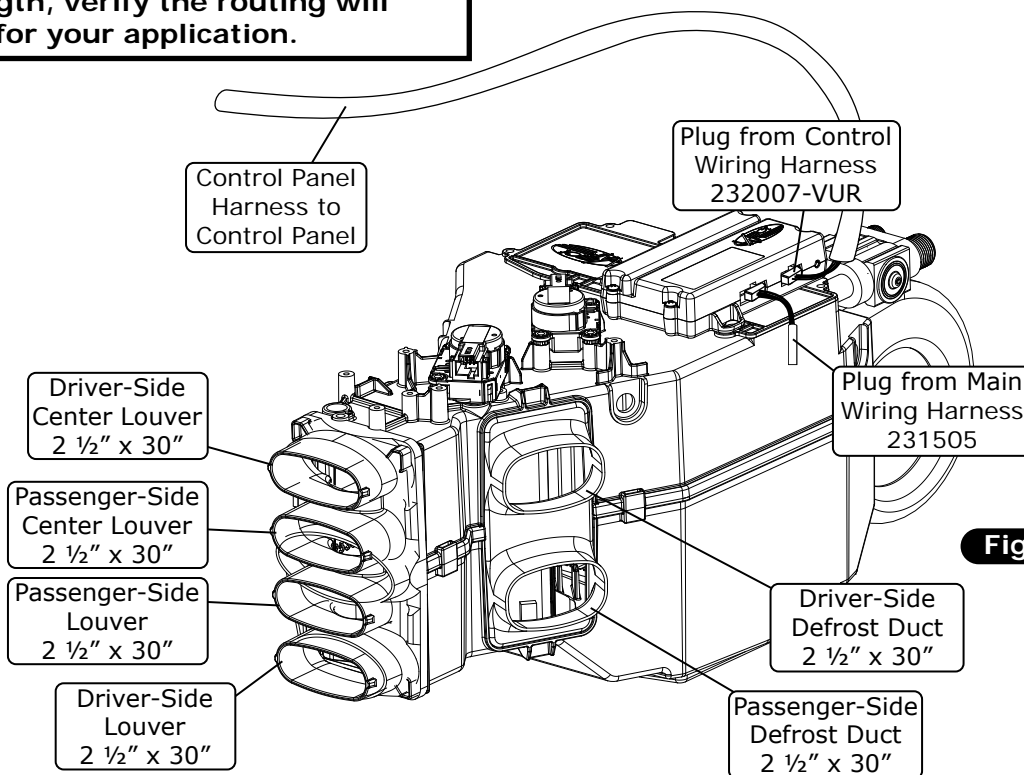

Figure 1



NOTE: ECU must be placed away from water and humidity, and also be accessible for servicing. If relocating, connectors must be positioned towards the bottom.

Position connectors towards bottom



www.vintageair.com

Quality Crimp Guideline

Acceptable strip length
(Some copper visible)

Crimped area is centered
on each side of splice

Bad strip length
(Too much copper visible)
Visible copper should be
just enough to ensure
clearance between splice
area and wire insulation

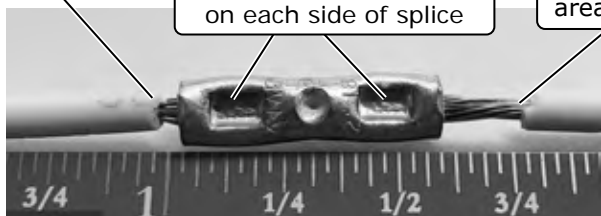

Photo 1

A good crimp requires
seam of butt splice to be
opposite of crimp die tooth

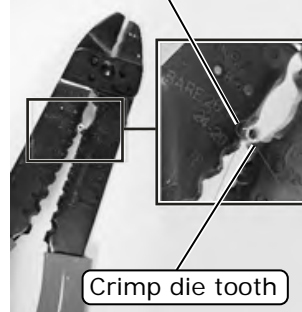

Photo 2

Good Ring Terminal Crimp Bad Ring Terminal Crimp



Crimped
area is
opposite
of seam

Photo 3

Crimp
area is
centered
on barrel

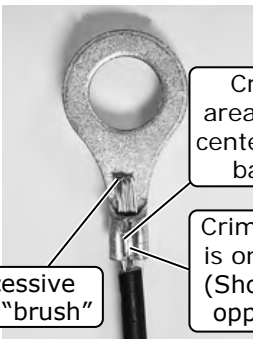

Crimp
area is not
centered on
barrel

Excessive
wire "brush"

Crimp
area
is on seam
(Should be
opposite)

Photo 4



Photo 5



Photo 5a

Use a ratcheting crimp tool
for insulated barrel terminals
when crimping the provided
female insulated terminal.
Ensure terminal is inserted in
appropriate position before
crimping.



www.vintageair.com

Gen 5 Wiring Diagram

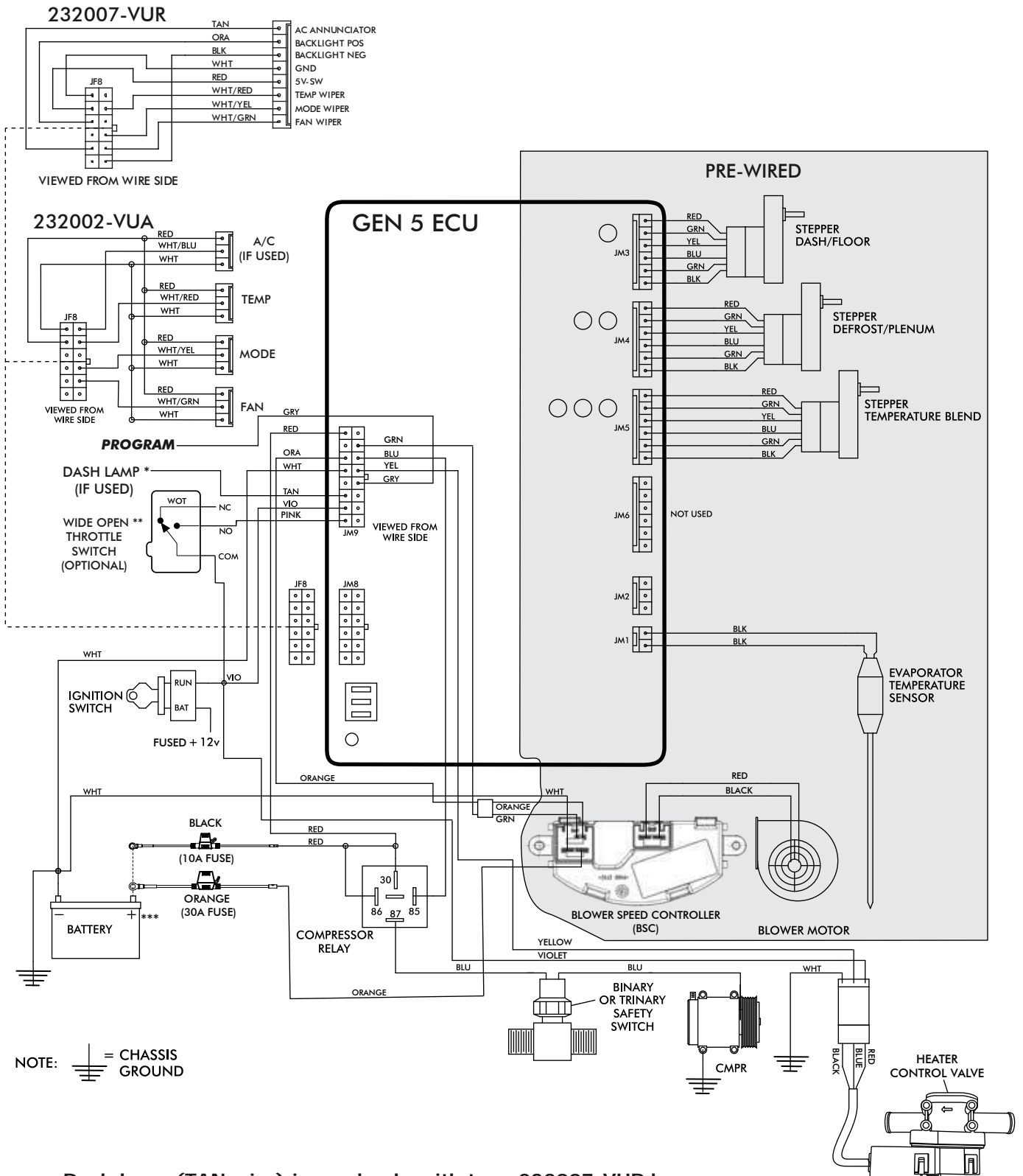

NOTE: = CHASSIS GROUND

- * Dash lamp (TAN wire) is used only with type 232007-VUR harness.
- ** Wide open throttle switch contacts close only at full throttle, which disables A/C compressor.
- *** Install fuse assemblies at or as near to the battery as possible.



www.vintageair.com

Gen 5 Wiring Instructions

WIRING HARNESS (231505) ↓

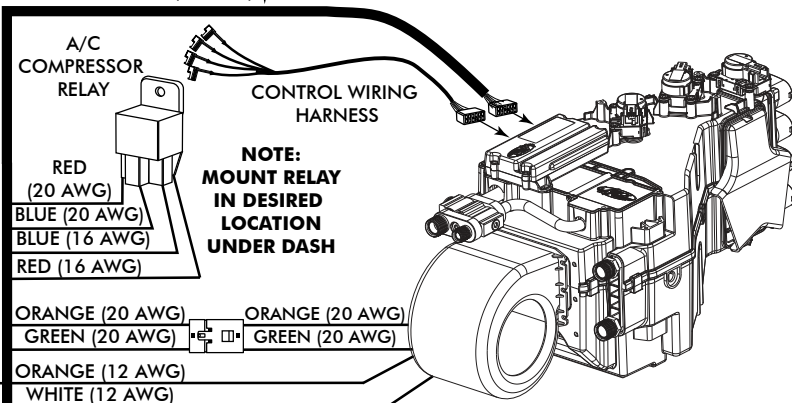

NOTE:
MOUNT RELAY
IN DESIRED
LOCATION
UNDER DASH

Ignition Switch:
Using provided butt splice (PN 226004), connect the 20 AWG violet wire to a 5A fused and switched 12V source such as Key On.

Wide Open Throttle Switch (Optional):
If a wide open throttle switch is required, connect the 20 AWG pink wire to a normally open switch that, when closed, connects a fused and switched 12V source to the pink wire. See Gen 5 wiring diagram for an example.

Dash Light (Optional):
If using a Vintage Air control panel with back light, connect the 20 AWG tan wire to the vehicle's dash back light 0-12V using provided butt splice (PN 226004).

WIRING HARNESS (232020) →

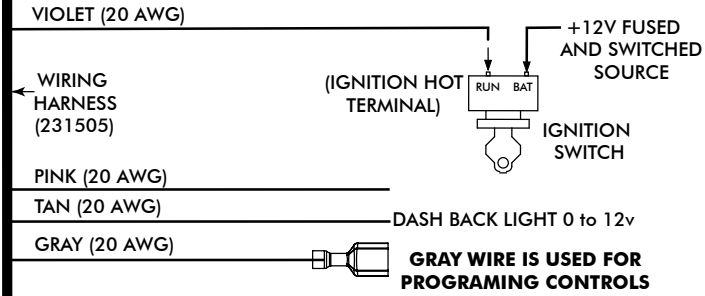

FIREWALL FIREWALL

WIRING HARNESS (232020) →

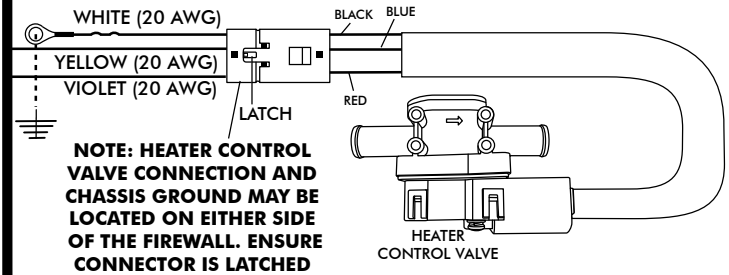

Heater Control Valve:
Connect the Violet/Yellow/White twisted branch with 3 position connector into the heater control valve connector. Ensure that the mating latch is fully seated.

Binary/Trinary & Compressor:
Binary Switch: Terminate provided insulated female terminal (PN 23172-VUW) to the blue 16 AWG wire. Connect as shown.
Trinary Switch: Connect according to trinary switch wiring diagram.

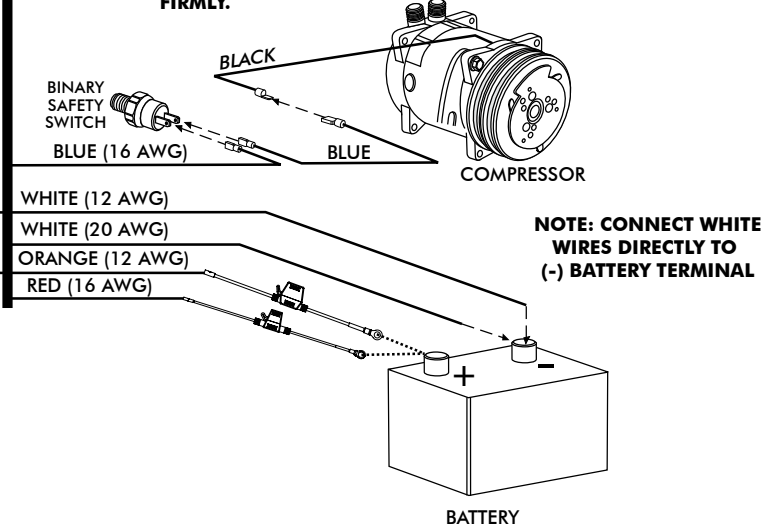

Battery Connections:
ECU Ground: Terminate provided ring terminal (PN 226110) to 20 AWG white wire from the 231505 wire assembly and install at battery.
ECU PWR: Terminate provided fuse assembly with black leads (PN 233012) to the 16 AWG red wire from the 231505 wire assembly. Install provided 10A Red Mini Fuse (PN 226118). Install at battery.
Blower Speed Controller (BSC) Ground: Terminate provided ring terminal (PN 226111) to 12 AWG white wire from the 232020 wire assembly and install at battery.
Blower Speed Controller (BSC) PWR: Terminate provided fuse assembly with orange leads (PN 233008) to the 12 AWG orange wire from the 232020 wire assembly. Install provided 30A Green ATO/ATC Fuse (PN 226125). Install at battery.



www.vintageair.com

Operation of Controls

On Gen IV and Gen 5 systems with three lever/knob controls, the temperature control toggles between heat and A/C operations. To activate A/C, move the temperature lever/knob all the way to cold and then back it off to the desired vent temperature. For heat operation, move the temperature lever/knob all the way to hot and then adjust to the desired vent temperature. The blower will momentarily change speed, each time you toggle in and out of heat and A/C operations, to indicate the change. **NOTE: For proper control panel function, refer to Pages 7 and 8 of the control panel instruction for calibration procedure.**

Blower Speed

This lever/knob controls blower speed, from OFF to HI.

Mode Control

This lever/knob controls the mode positions, from DASH to FLOOR to DEFROST, with a blend in between.

Temperature Control

This lever/knob controls the temperature, from HOT to COLD.

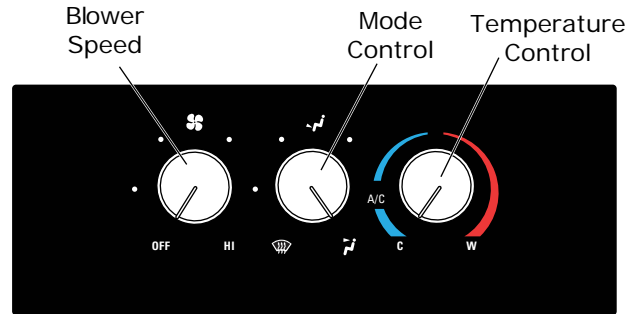

A/C Operation

Blower Speed

Adjust to desired speed.

Mode Control

Adjust to desired mode position (DASH position recommended).

Temperature Control

For A/C operation, adjust to coldest position to engage compressor (adjust between HOT and COLD to reach desired temperature).

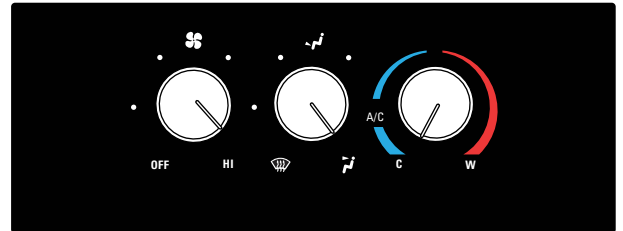

Heat Operation

Blower Speed

Adjust to desired speed.

Mode Control

Adjust to desired mode position (FLOOR position recommended).

Temperature Control

For maximum heating, adjust to hottest position (adjust between HOT and COLD to reach desired temperature).

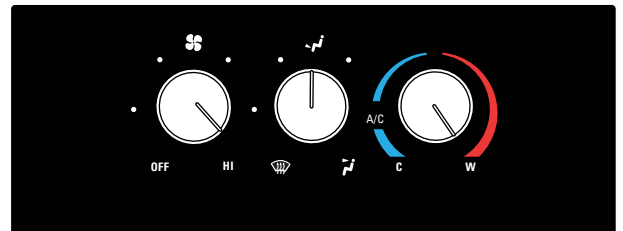

Defrost/De-fog Operation

Blower Speed

Adjust to desired speed.

Temperature Control

Adjust to desired temperature.

Mode Control

Adjust to DEFROST position for maximum defrost, or between FLOOR and DEFROST positions for a bi-level blend (Compressor is automatically engaged).

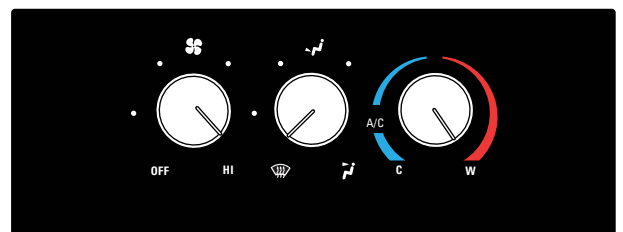



www.vintageair.com

Troubleshooting Guide

This printed troubleshooting guide is our basic guide that covers common installation problems. To see our advanced diagnostics and troubleshooting guide, please refer to the following page for instructions on how to download the complete guide.

WARNING: While troubleshooting the system, never probe connector terminals from the front mating side, only back probe.

WARNING: While troubleshooting the system, never use automotive check lights.

Symptom	Condition	Checks	Actions	Notes
1. Blower stays on high speed with ignition on.	No other functions work.	Check for damaged pins or wires in the control panel wire assembly and mating header at ECU.	If found damaged, replace wire assembly or ECU.	If fuse continues to blow, there is a serious problem in the wiring. Check all wiring and ensure the wire is not damaged and shorting out along its route.
	All other functions work.	Check for a bad ECU GND. Check for damaged pins or wires in the control panel wire assembly and mating header at ECU. Check if Blower power fuse is blown. Check for a bad ECU GND.	If found damaged, replace wire assembly or ECU. Replace fuse. Repair connection.	
2. Compressor will not turn on (All other functions work).	System is not charged.	System must be charged for compressor to engage.	Charge system.	Danger: Never bypass safety switch with engine running. Serious injury can result.
	System is charged.	Check for faulty A/C potentiometer or associated wiring (not applicable to 3-pot controls).	Check continuity to ground on white control head wire. Check for 5V on red control head wire.	To check for proper pot function, check voltage at white/red wire. Voltage should be between 0V and 5V, and will vary with pot lever position.
		Check for disconnected or faulty thermistor.	Check 2-pin connector at ECU housing.	Disconnected or faulty thermistor will cause compressor to be disabled.
3. Compressor will not turn off (All other functions work).	Compressor will not turn off (All other functions work).	Check for faulty A/C potentiometer or associated wiring.	Repair or replace pot/control wiring.	Red wire at A/C pot should have approximately 5V with ignition on. White wire will have continuity to chassis ground. White/Red wire should vary between 0V and 5V when lever is moved up or down.
		Check for faulty A/C relay.	Replace relay.	

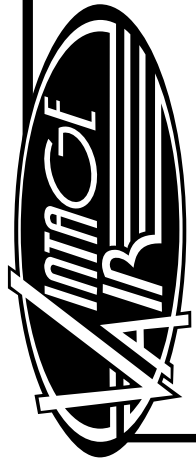

www.vintageair.com

Troubleshooting Guide (Cont.)

Symptom	Condition	Checks	Actions	Notes
4. System will not turn on, or runs intermittently.	Works when engine is not running; shuts off when engine is started	Noise interference from either ignition or alternator.	Install capacitors on ignition coil and alternator. Ensure good ground at all points. Relocate coil and associated wiring away from ECU and ECU wiring. Check for burned or loose plug wires.	Ignition noise (radiated or conducted) will cause the system to shut down due to high voltage spikes. If this is suspected, check with a quality oscilloscope. Spikes greater than 16V will shut down the ECU. Install a radio capacitor at the positive post of the ignition coil (see radio capacitor installation bulletin). A faulty alternator or worn out battery can also result in this condition.
	Will not turn on under any conditions.	Verify connections on power lead, ignition lead, and both white ground wires. Verify battery voltage is greater than 10 volts and less than 16 while engine is running.	Check for power at ECU, and confirm ignition is being applied to ECU properly. Verify proper meter function by checking the condition of a known good battery.	
5. Loss of mode door function.	No mode change at all.	Check for damaged mode switch or potentiometer and associated wiring.		
	Blower turns on and off rapidly.	Battery voltage is at least 12V. Battery voltage is less than 12V.	Ensure all system grounds and power connections are clean and tight. Charge battery.	System shuts off blower at 10V. Poor connections or weak battery can cause shutdown at up to 11V.
7. Erratic functions of blower, mode, temp, etc.		Check for damaged switch or pot and associated wiring.	Repair or replace.	

Advanced Diagnostics and Troubleshooting Guide

If after referencing the Troubleshooting Guide, the issue is not resolved, move to The Advanced Diagnostics and Troubleshooting Guide that covers the following:

- ECU Diagnostics Codes
- 1. **ECU Blink Sequence**
- 2. **Firmware Version Number**
- 3. **ECU Model Number**
- 4. **ECU Start-Up Blink Sequence**
- 5. Diagnostic Codes
- Complete Advanced Troubleshooting Guidelines

Access the latest version of the Advanced Diagnostics and Troubleshooting Guide by scanning the following QR code on your mobile device:



You can also access the guide by typing the following address into your web browser:

https://www.vintageair.com/instructions_pdf/905000.pdf



www.vintageair.com

Packing List: Evaporator Kit (554970)

No.	Qty.	Part No.	Description
1.	1	765200	Gen 5 Super Magnum Module with 404 ECU
2.	1	784970	Accessory Kit

Checked By: _____
Packed By: _____
Date: _____

1



Gen 5 Super Magnum
Module with 404 ECU
765200

2

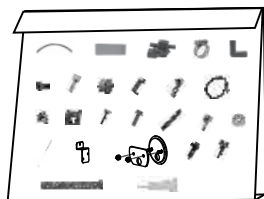
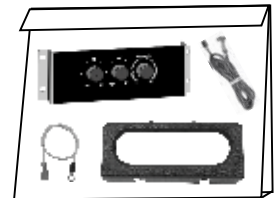
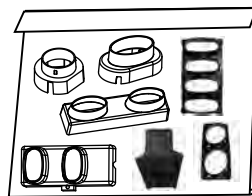
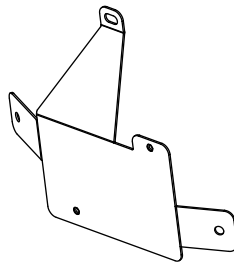
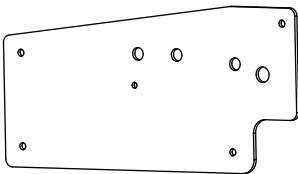
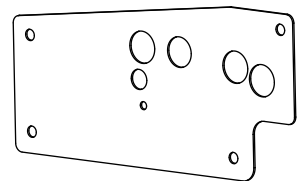
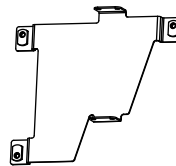
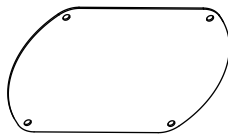
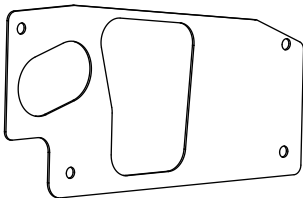
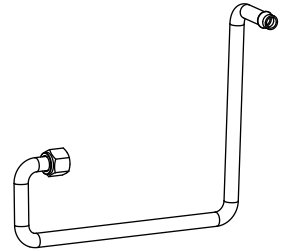
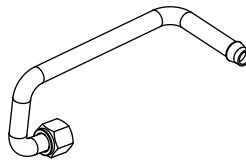
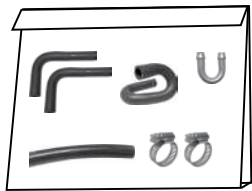

Accessory Kit
784970

NOTE: Images may not depict actual parts and quantities.
Refer to packing list for actual parts and quantities.